

# θ-features and Projection: Lecture 1

Richard Larson (Stony Brook University)

Thematic roles (or θ-roles) were introduced by Gruber and Jackendoff in the **semantic description** of predicates. θ-roles identify recurring parts individuals play in the actions or states that predicates describe; e.g., agent, theme, instrument, etc.

John opened the lock using that key  
 Mary surprised Bill with a new idea

**Agent:** John, Mary  
**Theme:** the lock, Bill  
**Instrument:** that key, a new idea

In *LGB*, Chomsky (1981) promotes θ-roles from semantic description to **syntactic composition**. LF becomes sensitive to their presence:

“Let us assume that LF must be so designed that such expressions as *the man, John, he* are assigned θ-roles, that is, are assigned the status of terms in a thematic relation. Let us call such expressions ‘arguments’.” (p. 35)

Special principles regulate their interaction with structure, e.g., the θ-Criterion:

“Each argument bears one and only one θ-role, and each θ-role is assigned to one and only one argument.” (p. 36)

This importance persists in the Minimalist Program (Chomsky 1995). The core structure-building operation of External Merge is conditioned by θ-role assignment.

**Questions:**

- What are θ-roles?
- What does it mean to assign a θ-role?
- Where does this device fit in C<sub>HL</sub>?

**My Proposals** (developing ideas by Hornstein 1999):

- θ-roles should be understood as syntactic features - **θ-features**
- θ-role assignment should be understood as **θ-feature agreement**
- θ-features show the properties of features generally, exhibiting interpretable/non-interpretable, valued/nonvalued instances, and showing concord.
- These ideas can underwrite a purely syntactic account of selection/projection.

Executing θ-roles as features is not obvious. As I will argue, it requires both the right semantic conception and the right view of its mapping to structure.

**Series plan:**

- **Lecture 1:** Background on shelled VPs, directions of development; θ-roles as syntactic features (θ-features) and an accompanying account of projection.
- **Lecture 2:** Ditransitive/applicative projection; history of derivational approaches;
- **Lecture 3:** Voice alternation; applicative shift (“A-Shift”); issues of case in VP; DP projection, genitives and G-Shift.

I welcome comments & follow-up inquiries by email (*Richard.Larson@stonybrook.edu*).

## 1.0 Origins of VP Shells

Many ideas behind shell structures have counterparts in the earliest work of Chomsky (1955/75), but the direct debt is to classical Montague Grammar.

(1) **The Rule to Rule Hypothesis**

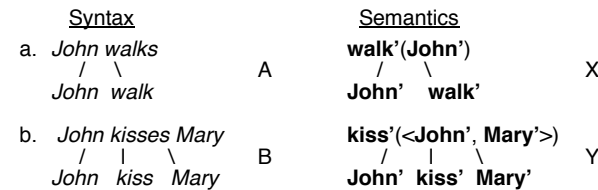

(2) **The Unary Function Hypothesis**

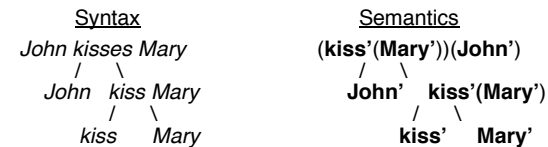

(3) **Semantic Approach to Grammatical Relations (Dowty 1978,1979)**

**Intransitive verb phrases (IVs)** denote functions mapping their arguments to a truth value. **Subjects** combine with IVs.

**Transitive verb phrases (TVPs)** denote functions mapping their arguments to the kind of function denoted by IV. **Direct objects** combine with TVPs.

**Ditransitive verb phrases (DVPs)** denote functions mapping their arguments to the kind of function denoted by TVP. **Indirect objects** combine with DVPs.

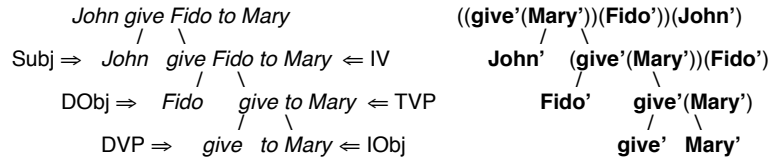

- (4) a. **Control Complements**  
 John persuade Mary to leave  
 John persuade Mary to leave  
 Mary persuade to leave  $\Leftarrow$  TVP  
 persuade to leave
- b. **Complex Predicates (Resultatives)**  
 John hammer the metal flat  
 John hammer the metal flat  
 the metal hammer flat  $\Leftarrow$  TVP  
 hammer flat
- c. **Control Adjuncts**  
 John buy the book to read  
 John buy the book to read  
 the book buy to read  $\Leftarrow$  TVP  
 buy to read
- d. **Discontinuous Idioms**  
 John put Mary on the spot  
 John put Mary on the spot  
 Mary put on the spot  $\Leftarrow$  Idiom TVP

1.1 "Right Wrap" and Merge

DO Merge in (4) is not (left/right) concatenation: DO is inserted into the predicate:

- (5) a. persuade **Mary** to leave  
 Mary persuade to leave
- b. hammer **the metal** flat  
 the metal hammer flat
- c. buy **the book** to read  
 the book buy to read
- d. put **Mary** on the spot  
 Mary put on the spot

This form of Merge – **Right Wrap** (RW) – has no counterpart in traditional phrase structure. How might RW derivations be captured in more standard representations?

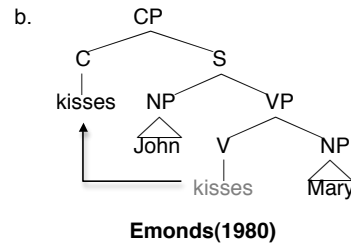
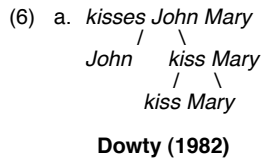

Idea: Extend the equivalence Right Wrap  $\approx$  V-Raising into VP

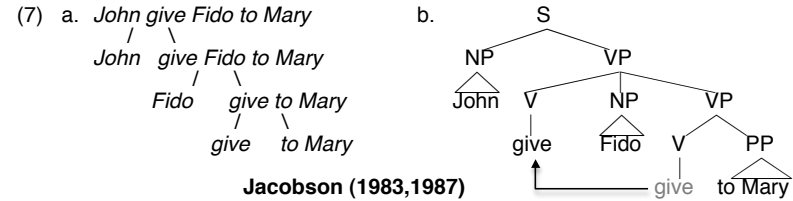

1.2 Points & Questions

- MG representations are binary branching; Jacobson's structures are ternary.
- MG derives binary branching in syntax as a reflection of the Unary Function Hypothesis in the semantics + the Rule to Rule Hypothesis.
- But in what sense is this **semantic structure**??
- If semantic structure is what must be attributed to derive correct truth-conditions, then the structure in unary functions is plainly not semantic.

These points suggested a fully binary, but more syntactic approach.

2.0 VP Shells

Larson (1988) proposes an account of projection allowing one to capture MG-style composition using conventional phrase markers with verb-raising. Three parts.

- (8) a.  $XP \rightarrow \text{Spec}X' X'$   
 b.  $X' \rightarrow X ZP$  (Single Complement Hypothesis)
- (9) P1: If  $\alpha$  is a predicate and  $\beta$  is an argument of  $\alpha$ , then  $\beta$  must be realized within a projection of  $\alpha$
- (10) a. Thematic Hierarchy  
 $\Theta_{\text{AGENT}} > \Theta_{\text{THEME}} > \Theta_{\text{GOAL}} > \Theta_{\text{OBLIQUE}}$  (manner, location, time,...)  
 b. P2: If a verb determines  $\theta$ -roles  $\theta_1, \theta_2, \dots, \theta_n$ , then the lowest role on the Thematic Hierarchy is assigned to the lowest arg in structure, the next lowest role to the next lowest arg, etc.

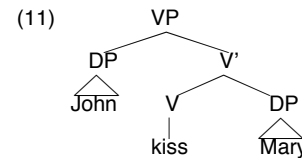

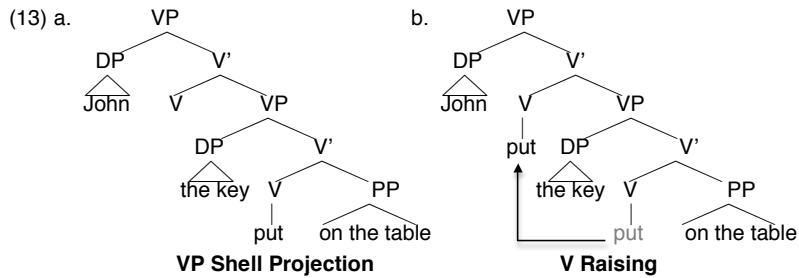
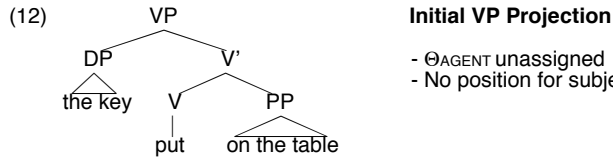

This account can extend to (4a-d) if the lowest phrases (CP, AP, PP) are analyzed as oblique V complements:

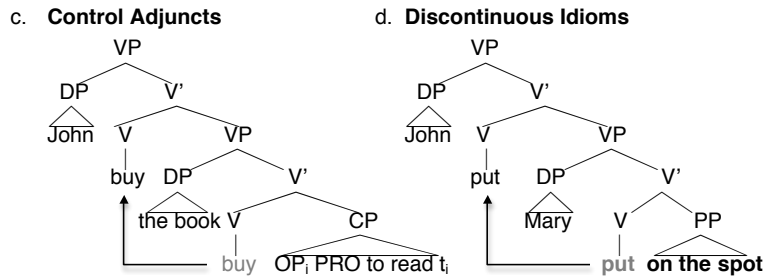
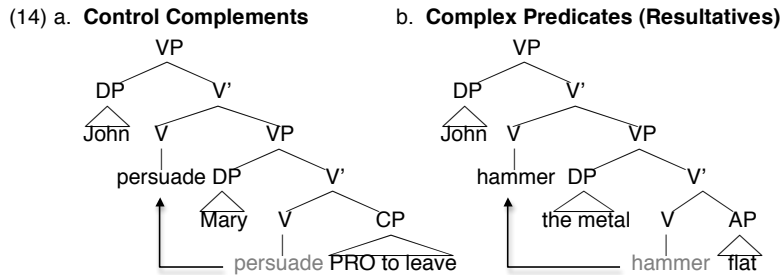

**2.1 Properties of Shell Structures**  
**2.1.1 Generalized structural asymmetry**

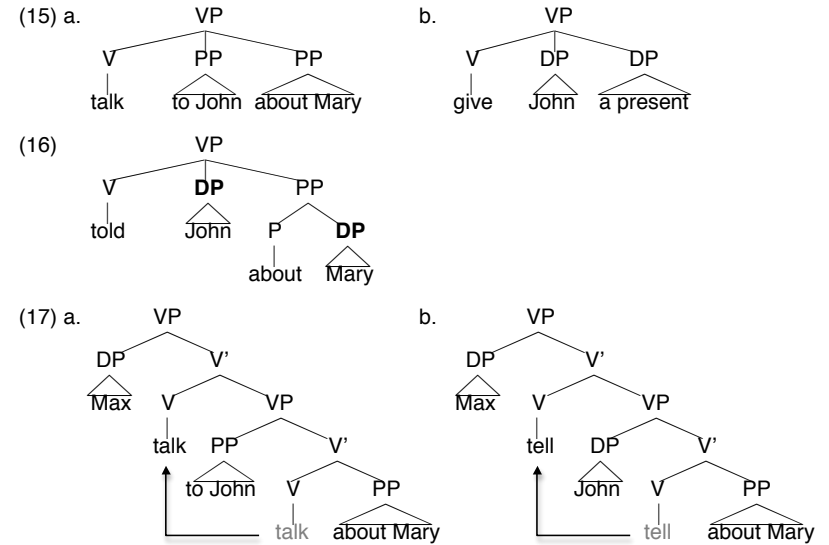

**2.1.2 Recursivity**

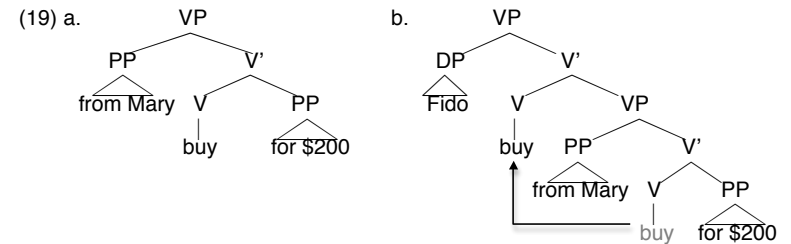
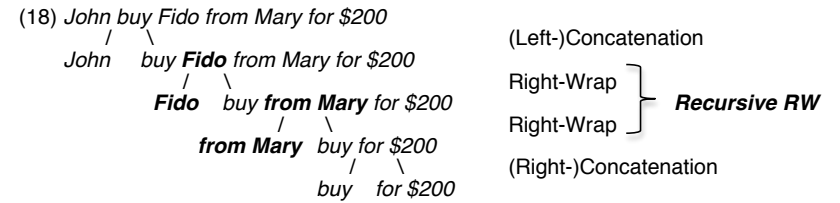

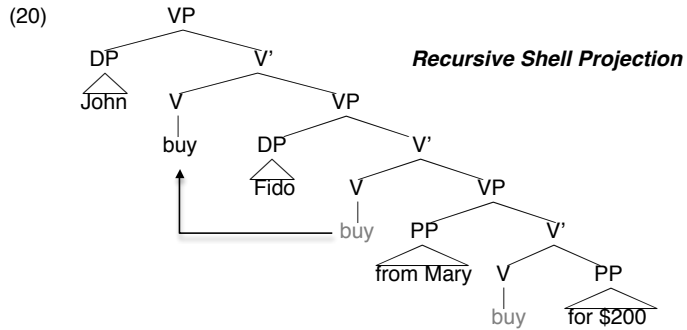

**2.1.3 Category Neutrality**

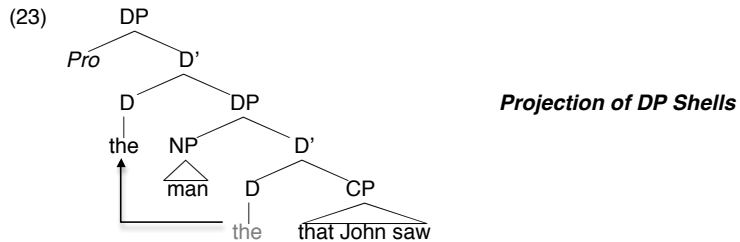
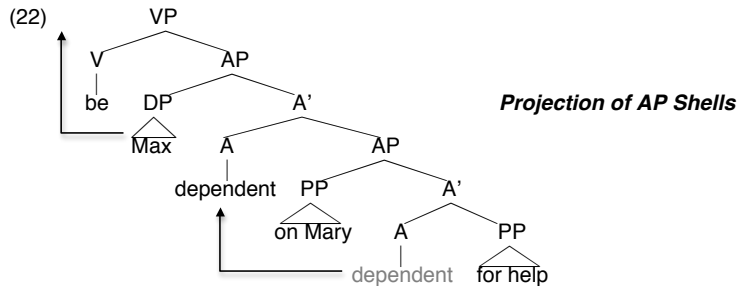
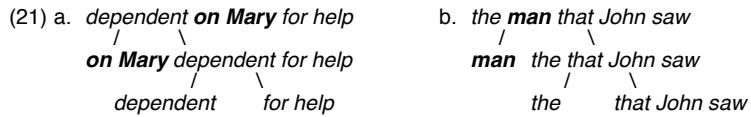

**2.2 Problems & Developments**

- What motivates head raising between shells? (Case, need for proper government of empty elements?)
- How does shell projection actually work?

**Basic idea:** invert the logic of the EPP, in which introduction of a head (T) forces projection of a subject specifier position, purely as a consequence of X-bar theory. With shells, the need to project a specifier forces introduction of an empty X head for the same reason.

**But:** the cases aren't truly symmetric. Spec projection can be accommodated within standard views of structure building; head projection can't:

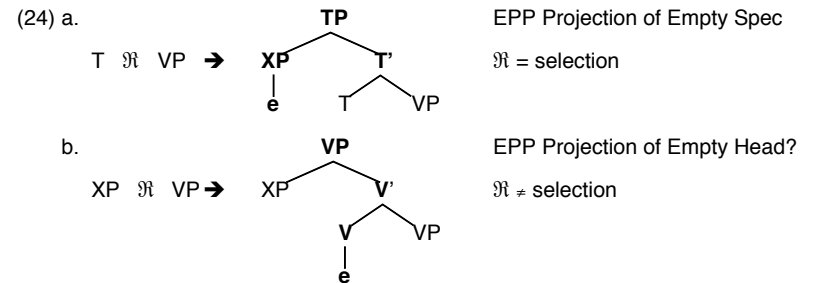

**3.0 Empty V as Null Causative?**

**Fully Decompositional Approaches**

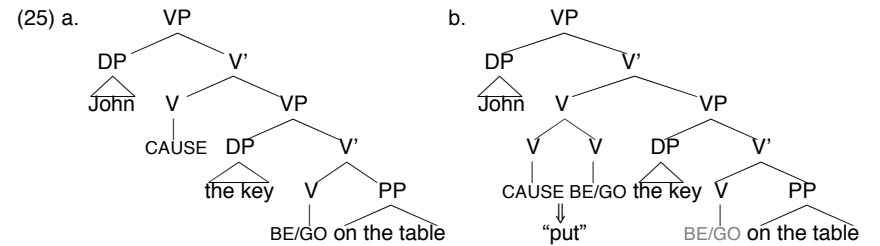

Full decomposition incurs a commitment to exhaustive semantic analysis very hard to carry beyond initial intuitions (26a,b).

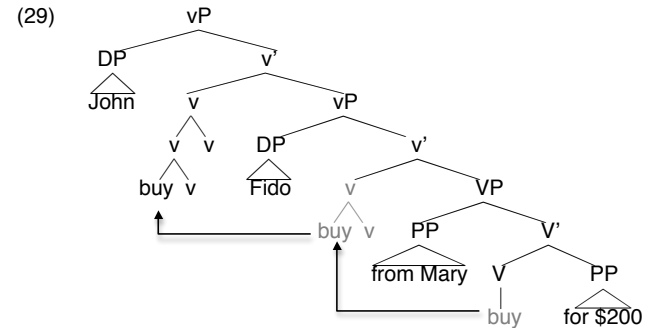
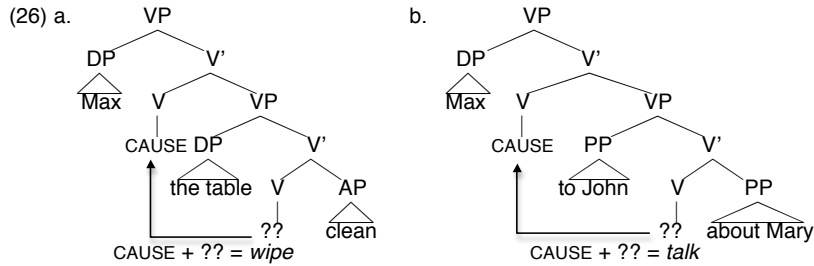

**Partially Decompositional Approaches**

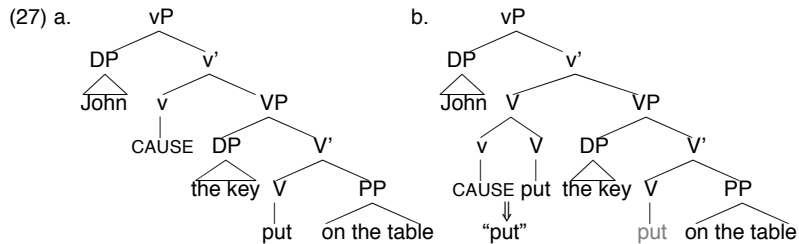

If v is analyzed as the uniform source of the agentive thematic role, then it must be present whenever the latter is assigned:

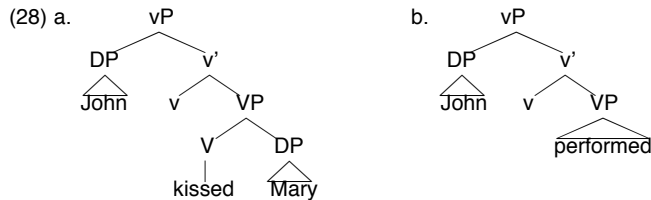

In any case, this is very different from shell theory.

- No general commitment to right-descent (29).
- No recursivity. (29a) cannot deploy the same little v in both positions (there aren't two agents). If the lower v is the source of the theme role, then it should occur in (27) too.
- No category neutrality. v is associated with specifically verbal semantics (causation). In shell theory, v is simply a structural placeholder.

**4.0 Theta-theory and Semantic Composition**

Larson (1988) assumed GB-style θ-theory; predicates bear a set of θ-roles assigned to arguments in the derivation, as governed by the θ-Criterion:

**θ-Criterion:** Each argument bears one and only one θ-role, and each θ-role is assigned to one and only one argument. (Chomsky 1981, p.36)

This view dovetails neatly with the semantic analysis of predicates & selection that was prevalent at the time, and which remains a standard one in formal semantics.

**4.1 The Standard Semantic Analysis**

Predicates denote n-ary relations on individuals, nominals (and other arguments) denote the individuals related: semantic composition puts the two together:

(30) John gave Mary Fido.

(31) a. **give'(j,m,f)**

- b. *gave* → λzλyλx[**give'**(x,y,z)]
- John* → j
- Mary* → m
- Fido* → f

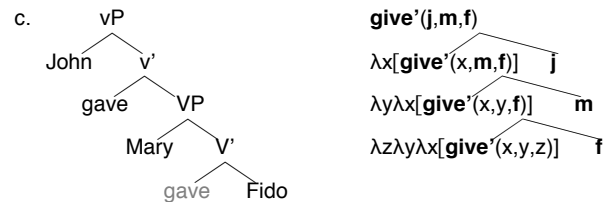

A natural semantic interpretation for GB-style notions of θ-theory:

- give assigns three θ-roles ↔ give' is a ternary function
- give must assign all three θ-roles for well-formedness ↔ give' must combine with three args in order to denote a truth-value
- all argument expressions must bear a θ-role ↔ corresponding individuals must be the args of some predicate function in order to be integrated into semantic composition

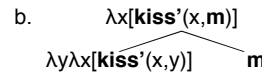
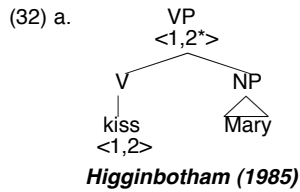

Neo-GS predicate decomposition doesn't alter this picture in any significant way:

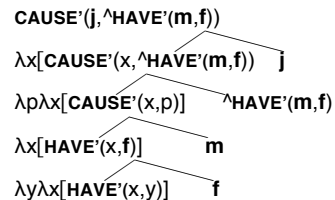
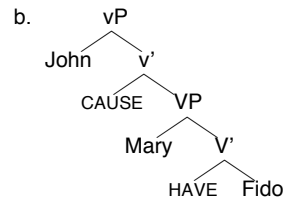
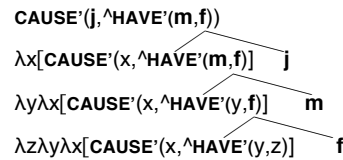
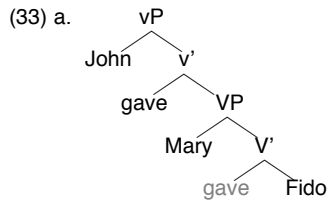

#### 4.2 Neo-Davidsonian Semantic Composition

Neo-Davidsonian accounts analyze (30) as in (34). Give' doesn't relate m, j, and f directly, but rather denotes a unary predicate of events to which the arguments are related by means of binary relations.

(34)  $\exists e[\text{give}'(e) \ \& \ \text{Agent}(e,j) \ \& \ \text{Goal}(e,m) \ \& \ \text{Theme}(e,f)]$

Whereas neo-G proposes **predicate decomposition**, neo-D proposes **argument separation**.

#### 4.2.1 The P Analysis

One possible syntax-semantics mapping for (34) is (35). Call this the "P Analysis" since it is urged by Parsons (1990).

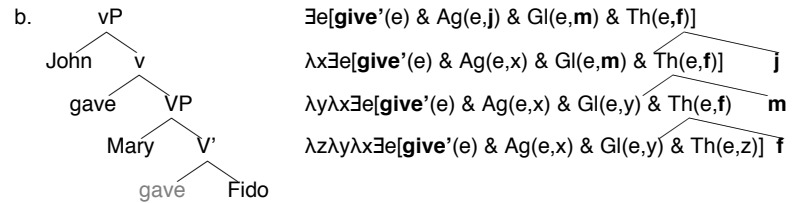
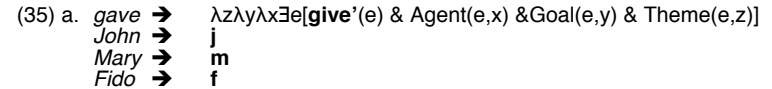

Event structure is sublexical/"subatomic": (35a) is just a more articulated version of (31a). The semantic interpretation of θ-roles & θ-Criterion from the Standard Analysis are preserved in (35).

#### 4.2.2 The K Analysis

Consider the alternative syntax-semantics mapping in (36). Call this the "K Analysis" since it derives from proposals by Krifka (1998).

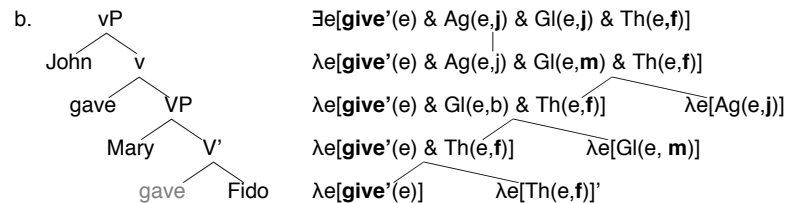
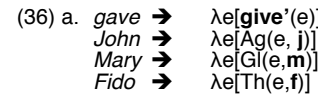

K Analysis derives the same semantic result for sentence (30), but follows a very different route. This difference has dramatic consequences.

No natural semantic interpretation for GB-style notions of θ-theory:

- give assigns three θ-roles ↔ give' is a unary function on events !
- predicates must assign all θ-roles for well-formedness ↔ ???
- args must bear θ-roles for well-formedness ↔ ???

- (37) a. \*Mary demands. (Demands what??)  
 b. \*John put the book. (Put it where??)

(38) \*Mary yawned Alice.

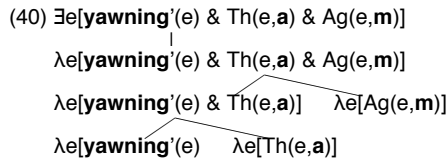
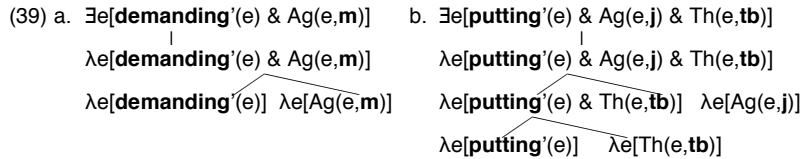

These results apply to both lexical and functional heads. Consider the idea that voice heads and Ps semantically “introduce arguments”:

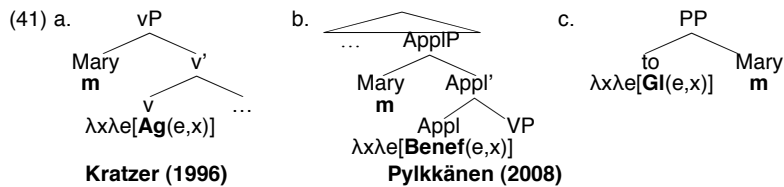

K Analysis doesn't support this (42a-c). Functional heads can't be needed to license arguments in any semantic sense.

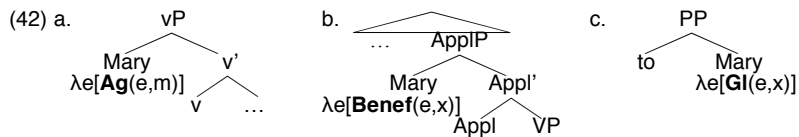

### 5.0 $\theta$ -roles as Formal Features

The K analysis suggests a strictly syntactic view of selection,  $\theta$ -roles and  $\theta$ -assignment. How should we think of this?

**Hornstein (1999):** Represent  $\theta$ -roles as syntactic features -  $\theta$ -features. Analyze selection/ $\theta$ -assignment as  $\theta$ -feature agreement.

### 5.1 Features & Agreement

Pesetsky and Torrego (2004) take features to come in four varieties, according to whether they are **interpretable/uninterpretable** or **valued/unvalued** (43).

(43)

	INTERPRETABLE	UNINTERPRETABLE
VALUED	iFval	uFval
UNVALUED	iF	uF

Two occurrences of a feature can undergo agreement, producing two instances of what becomes a single feature:

- (44) **Agree (Feature sharing version)**
- (i) An unvalued feature F (a probe) on a head H at syntactic location  $\alpha$  ( $F_\alpha$ ) scans its c-command domain for another instance of F (a goal) at location  $\beta$  ( $F_\beta$ ) with which to agree.
- (ii) Replace  $F_\alpha$  with  $F_\beta$ , so that the same feature is present in both locations.

(45) ... uF[ ] ... uF[ ] ...  $\Rightarrow$  **AGREE**  $\Rightarrow$  ... uF[3] ... uF[3] ...

Only features **both** interpretable & valued will be legible to the interfaces.

For P&T, features like (46a-d) will be legible, but (47a-e) will not:

- (46) a. iFval[ ]                      b. iF[n] ... uFval[n]  
 c. iF[n] ... uF[n] ... uFval[n]    d. iF[n] ... uF[n] ... uF[n] ... uFval[n]
- (47) a. uFval[ ]                      b. uF[n] ... uFval[n]  
 c. iF[ ]                              d. iF[n] ... uF[n]  
 e. iF[ ] ... uFval[ ]

Summarizing:

- an interpretable occurrence of F will need to agree with a valued occurrence of F,
- a valued occurrence of F will need to agree with an interpretable occurrence of F,
- an uninterpretable, unvalued occurrence of F will need to agree with both.

### 5.2 $\theta$ -Features and $\theta$ -Agreement: predicate – object

Consider  $\theta$ -features in P&T's terms. Suppose we have [AG], [TH], [GL], etc.

Assume the selection relation between a predicate and an object is  $\theta$ -feature agreement (48).

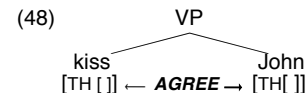

**Questions:**

- Which elements of structure carry interpretable θ-features?
- Which elements of structure carry valued θ-features?
- Which elements of structure carry uninterpretable/unvalued θ-features?

K analysis implies:

θ-features are interpretable on argument nominals (not on predicates!).

Thus *John* in (29) should bear [iTH[ ]], interpreted at the interface as λe[Th(e,j)].

If [TH] is interpretable on *John* in (48), it's natural to assume [TH] is valued on V. [iTH[ ]] probes [uTHval[ ]] on *kiss* and they agree (49):

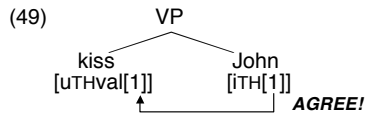

The result is an LF-legible feature.

**External Merge:** Merge accompanied by θ-feature agreement.

(49) thus instantiates External Merge.

**5.3 θ-Features and θ-Agreement: subject – predicate**

Suppose we wish to merge a nominal *Mary* with structure (49) as subject. *Mary* should bear the interpretable θ-feature, here [AG]. If *kiss* bears a valued [AG] feature, things go as above. *Mary* combines by External Merge (50).

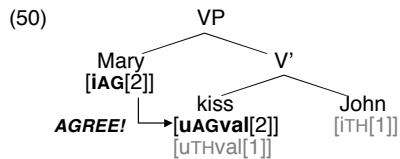

**Thought experiment:** Suppose predicates can't bear more than a single valued θ-feature. I.e., suppose bundled θ-features are treated like a single feature: only one value is allowed. Suppose that [TH] is the valued feature in the default case - a special status for themes.

If *kiss* bears an unvalued occurrence of [AG], *Mary* can still externally merge; θ-feature agreement can still occur (51):

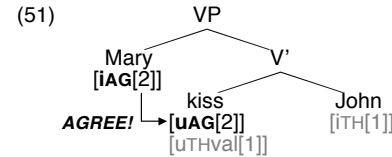

BUT [AG] is now unvalued. Unvalued features are interface illegible!

Suppose when we select a Numeration containing V, we may co-select a “light v”.

**Light v:** Bears a strong V feature. Bears an EPP feature. Bears one valued occurrence of a θ-feature unvalued on a V with which it was co-selected.

This permits a Numeration for (51) that includes a light v carrying [uAGval[ ]]. Merge this with (49); V raises and v-V agree (52).

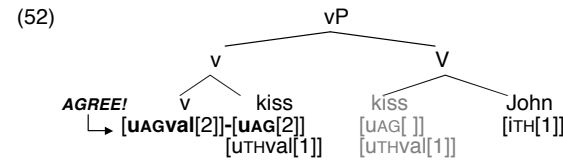

*Mary* can now merge with this structure, satisfying v's EPP feature. Unvalued [iAG[ ]] on *Mary* probes valued [uAGval[2]] on v and Agrees.

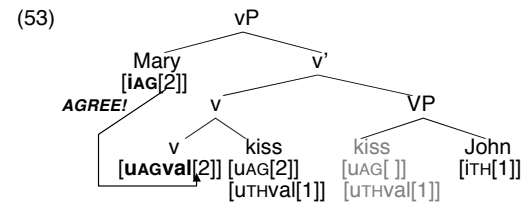

The result is now an LF-legible feature, and an interface-legible structure.

This reconstructs “little v” in a **purely formal role** – not as an empty causative, nor any sort of semantically contentful head, but as the bearer of a valued (uninterpretable) θ-feature.

**Idea:** Little v arises from unavailability of the simplex (54a). The second value materializes as a separate verbal head, bound to its parent by a strong V “force” (54b). The grammar subsequently constructs the legitimate, complex object (54c), equivalent to the simplex object that is proscribed:



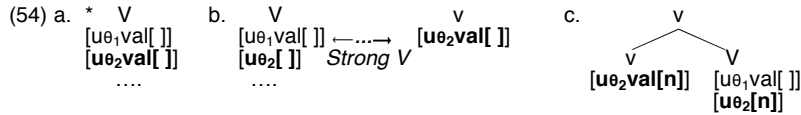

**Voice Head:** Little v bearing valued (uninterpretable) θ-features.

**Question:** What determines merge in the order shown? I assume a version of the Thematic Hierarchy, and a constraint on order of agreement in sets of θ-features.

- (55) a. **Hierarchy of θ-features:** [AG] > [TH] > [GL] > [LOC] > ...  
 b. **Constraint:** A feature in a set subject to a hierarchy can undergo agreement only if there are no lower-ranked, unagreed features in that set.

In (53), agreement with [AG] in {[AG],[TH]} for *kiss* occurs only after [TH] undergoes agreement. Hence (55b) is satisfied.

**5.4 θ-Features and θ-Agreement: predicate – oblique argument**

Consider ditransitive *give*. Suppose it has θ-features as in (56):

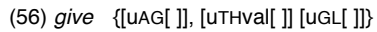

This looks traditional: *give* selects agent, theme and goal. But again, none of these θ-features is interpretable. And only one is valued!

Goal must merge first. But direct merger yields the problem in (50): an interpretable, unvalued feature (57).

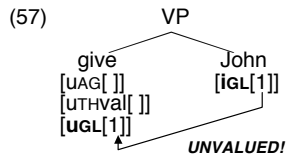

Suppose P, like v, can bear valued [θ]. *To* bearing valued [GL] can merge externally with *John* (58a). And PP can externally merge *give*; the unvalued [GL] feature on V probes the valued [GL] feature on *to* (58b):

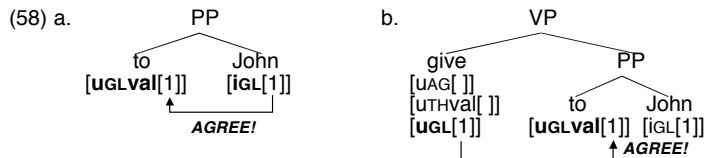

The rest goes as before. The theme merges directly and unproblematically since [TH] is valued on *give*. The agent is valued by little v, which also raises V (59):

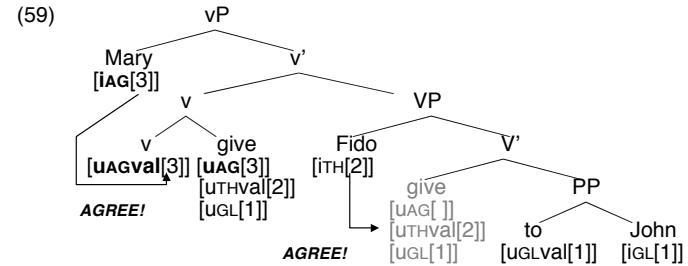

This reconstructs P in a **purely formal role** – not as a θ-relation-contributing head, but as the bearer of a valued (uninterpretable) θ-feature

**5.5 Multiple Oblique Arguments and Recursion**

Reconsider (60), assuming it to select four args: agent (*John*), theme (*Fido*), source (*from Mary*), and a “remuneration phrase” (*for \$200*).



Assume the ranking [AG] > [TH] > [SRC] > [REM]. We construct the lowest VP by External Merge (61).

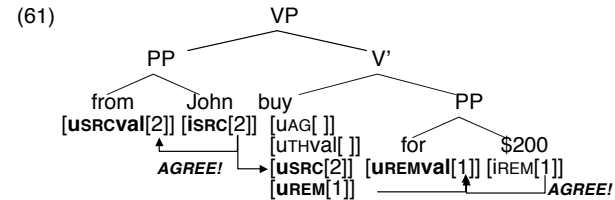

**NB:** I must assume here (and hereafter) that PP structure quite generally does not “count” for c-command in agreement relations. This assumption seems independently required for binding (cf. *a letter [from John] [about/to himself]*).

Consider addition of the theme. Simplest would be to merge *Fido* directly with (61), [iTH] on *Fido* agreeing with [uTHval] on *buy*:

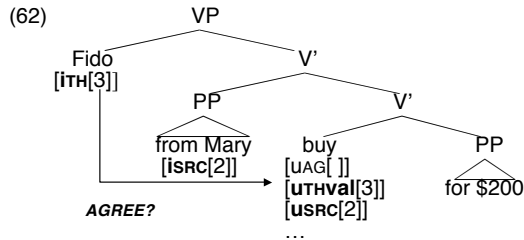

θ-feature agreement must extend across *from Mary*, which also stands in a θ-feature agreement relation to *buy* and is closer to V than *Fido*.

**Minimality Constraint on Feature-Agreement:** For any α, β, and γ, α cannot agree with a feature from F on γ across a closer β that also agrees with a feature from F on γ.

Assuming θ-features constitute a class F to which Minimality is sensitive, this constraint excludes external merger of an additional specifier as a way to project an additional argument. What's left?

**Light v:** Bears a strong V feature. Bears an EPP feature. May bear one valued occurrence of a θ-feature unvalued on a V with which it was co-selected.

New possibility:

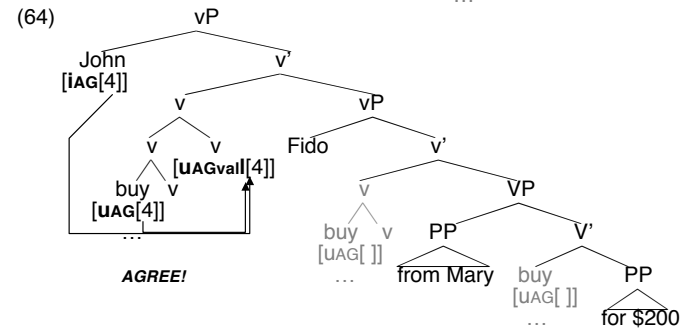
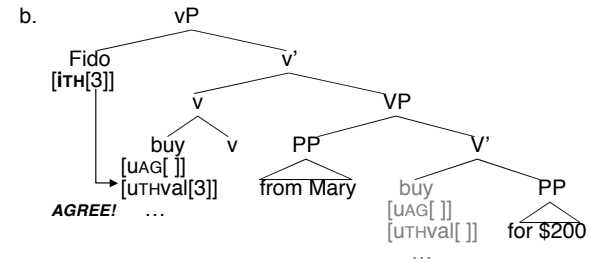
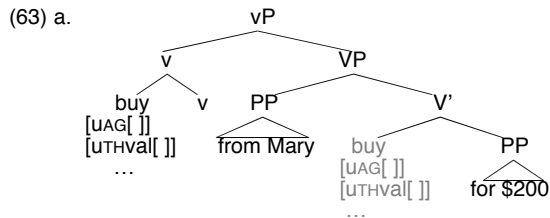
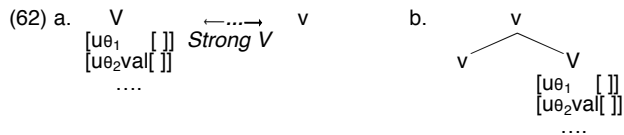

### 5.6 Properties of the Revised Account

This analysis yields basic shell structure with no appeal to X-bar theory, and none either to full or partial lexical decomposition.

Light v makes its appearance on purely formal grounds:

- distribution of θ-features,
- nature of agreement,
- Minimality constraints on the agreement relation

Light v has the effect of “separating” specifier arguments in such a way that their agreement relations to the head never cross (65):

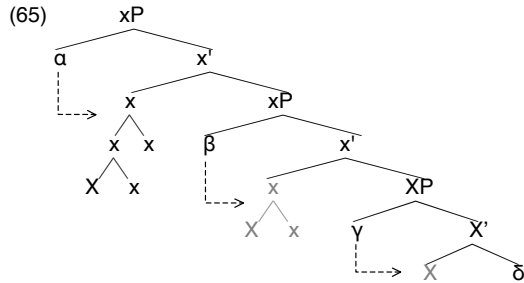

**Generalized asymmetry:** Follows from basic account of structure building.

**Recursivity:** Preserved through “pure” light v’s

Suppose *buy* in (66a) is analyzed as bearing an unvalued instance of [LOC], with [LOC] ranked below [REM]. We can extend the analysis of (60) to (66a). Adding two pure light v’s to the Numeration, and merging them in the lowest stages, permits (66b), involving recursive little v:

(66) a. John bought [Fido] [from Mary] [for \$200] [in NYC].

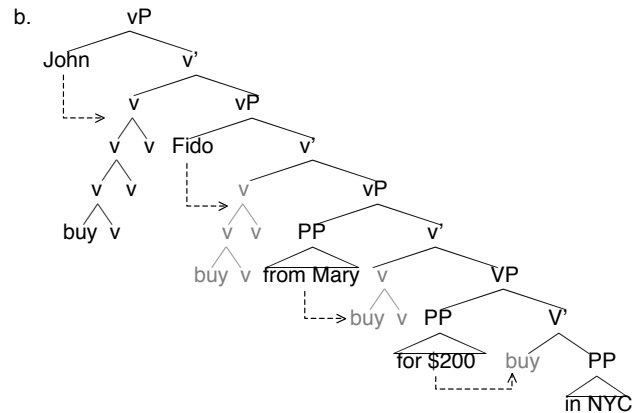

**Category neutrality:** Also preserved. The derivations above involve two components beyond the standard ones:

- ranked set of theta-features
- availability of light heads, either pure or bearing valued  $\theta$ -features

Neither is tied essentially to the verbal domain

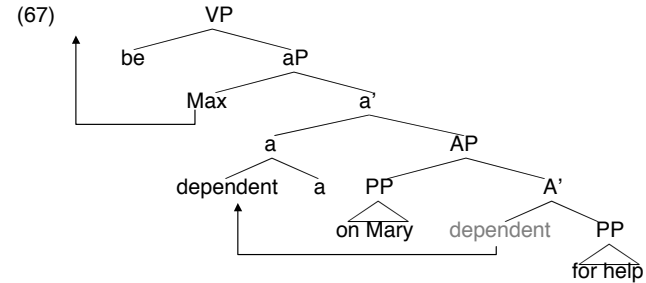

(68) a.

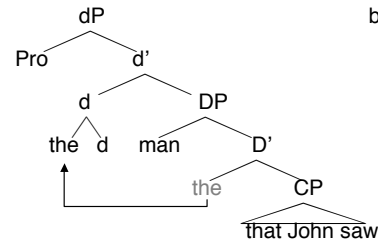

b.

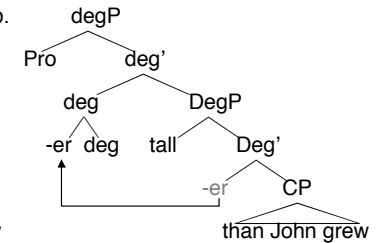

## Summary

Today we looked at:

- the historical origins of shell theory as an attempt to import Right Wrap derivations into the EST
- the properties of shell theory (generalized asymmetry, recursivity, categorial neutrality)
- the problems of that theory (dependence on X-bar theory)
- the attempt to understand structured VPs in terms of (neo-)Generative Semantics predicate decomposition
- the logic of  $\theta$ -roles under the “standard” Fregean semantic picture
- the possibilities for re-thinking that logic under a neo-Davidsonian semantics – specifically the “K analysis”
- an execution of  $\theta$ -roles as features in the terms of Pesetsky & Torrego (2004) and the K analysis
- an account of structure building in these terms, one which reconstructs shell structure and inherits its essential properties

**Next time:**

A review of dative projection and an extension of this picture to voice alternation.

Thank you!

# θ-features and Projection: Lecture 2

Richard Larson (Stony Brook University)

Shell theory was first developed to provide an analysis of dative constructions

- Control with *promise* seemed to point toward a “Dative Shift” analysis; but Dative Shift was abandoned within transformational grammar after the work of Oehrle (1976).
- Barss and Lasnik (1986) drew attention to domain asymmetries like those in (1) and (2) in PP and double object datives.

Asymmetry in (1a-d) can be explained without recourse to linearity, by appeal to the PP node in (3a). But asymmetries in (2) cannot on the simplest structural hypothesis available at the time (3b).

- (1) a. Mary showed **John** to **himself**/\*Mary showed **himself** to **John**.  
 b. Mary sent **every check** to **its** owner/  
 \*Mary sent **his** paycheck to **every** worker.  
 c. Mary gave **nothing** to **anyone**/Mary gave **anything** to **no one**.  
 d. John sent **each girl** to **the other’s** parents/  
 \*John sent **the other’s** daughter to the **each** parent.
- (2) a. Mary showed **John himself**/\*Mary showed **himself John**.  
 b. Mary sent **every worker his** paycheck/  
 \*Mary sent **its** owner **every** paycheck.  
 c. Mary gave **no one anything**/\*Mary gave **anyone nothing**.  
 d. John sent **each parent the other’s** daughter/  
 \*John sent **the other’s** parent **each** daughter.

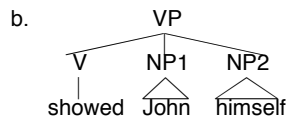
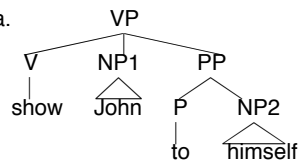

I was struck by this puzzle, in part because I thought I already knew the answer to it!

MG derivations for prepositional datives posited a deeper asymmetry between verbal arguments (4a,b).

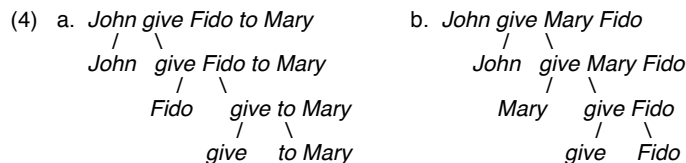

MG derivations also suggested an attractive way of updating “dative shift” and using it to explain control relations:

- (5) a. [<sub>VP</sub> John [<sub>V</sub> write [<sub>VP</sub> [<sub>DP</sub> a letter] [<sub>V</sub> write [<sub>PP</sub> to Mary]]]]]  
 b. [<sub>VP</sub> a letter [<sub>V</sub> [<sub>V</sub> written a letter ] [<sub>PP</sub> by John ]]]  
 c. [<sub>VP</sub> John [<sub>V</sub> write [<sub>VP</sub> Mary [<sub>V</sub> [<sub>V</sub> write Mary ] [<sub>DP</sub> a letter]]]]]

Asymmetric c-command

Passive

Dative Shift

- (6) a. John promised to leave to Mary  
 b. [<sub>VP</sub> <sup>AGENT</sup> John [<sub>V</sub> promise [<sub>VP</sub> [<sub>CP</sub> PRO to leave] [<sub>V</sub> promise [<sub>PP</sub> to <sup>GOAL</sup> Mary]]]]]

Control

- (7) a. John promised Mary to leave  
 b. [<sub>VP</sub> <sup>AGENT</sup> John [<sub>V</sub> promise [<sub>VP</sub> Mary [<sub>V</sub> [<sub>V</sub> promise <sup>GOAL</sup> Mary ] [<sub>CP</sub> <sup>THEME</sup> PRO to leave ]]]]]]

Control + Dative Shift

## 1.0 Projecting Datives

Interest in dative structures has been strong since the late 80s, but the dominant approaches have been non-derivational. Overwhelmingly, PP dative and double object datives have been analyzed as independent constructions, separately projected.

### 1.1 What Kind of Information is Relevant to Projection?

Two constructions are projected separately = elements of the constructions differ in properties relevant to projection.

What properties are relevant?

- (8) a. I taught French to those children.  
 b. I taught those children French.
- (9) a. I knitted this sweater for our baby  
 b. I knitted our baby this sweater.

Differences of affectedness in (8a,b)/(a,b) are surely **conversational implicatures** since cancellable (10a,b):

- (10) a. I taught those children French for a whole year. But the final exam results showed the little brats hadn’t learned a damn thing.  
 b. I knitted our baby this sweater. I just hope it fits him when he’s born.

Pragmatics is interpretive, not generative. Conversational implicatures are calculated from the syntax and semantics, not determinative of syntactic projection.

**Implication:** Contrasts like (8a,b)/(9a,b) are irrelevant to issues of dative projection.

Differences of projection among Vs have been widely ascribed to either:

- Relations that individuals or entities can bear to the event or state that the verb describes – θ-roles, or
- Core predicates into which the predicate can be decomposed.

- (11) a. Job blamed God for his troubles.  
 b. Job blamed his troubles on God.
- (12) a. Job thanked God for his blessings.  
 b. Job gave God thanks/gave thanks to God for his blessings.
- (13) a. Job put his troubles on God.  
 b. Job put the blame for his troubles on God.

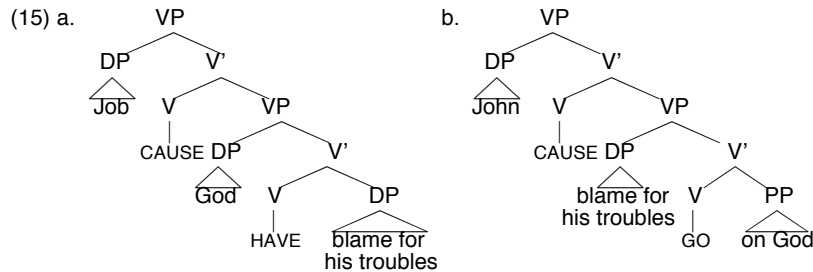
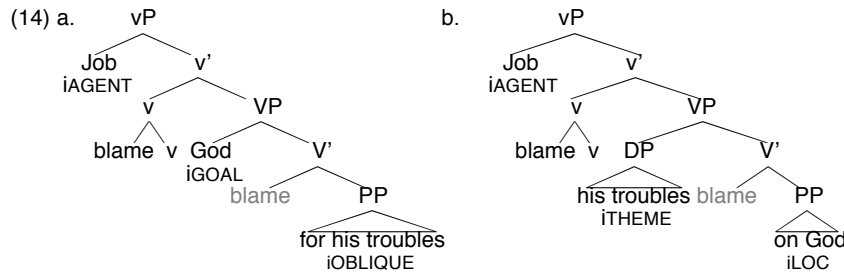

On the former, *blame* gets two distinct lexically specified θ-sets. On the latter, *blame* spells out two distinct merged predicates: ‘cause-to-have/get-blame’ and cause-blame-to-go’. Etc.

### 1.2 Separating Double Object Constructions from Oblique Locatives

Separate projection for the two senses of *blame* in (11a,b) seems sensible given differences in word order, preposition choice, and semantic intuitions.

What about datives?

Many have applied analogous reasoning to DO and PP datives. Pinker (1989), Goldberg (1995); Harley (1995,2002), Krifka (1999); Richards (2001), Beck and Johnson (2004) amo, have assumed DO Vs encode caused-possession whereas PP dative Vs encode caused-motion or caused-location.

**Example:** Vs of transmission (*send*) and ballistic motion (*throw*).

- (16) a. John **sent** Mary a telegram.  
 b. John **sent** a telegram to Mary.

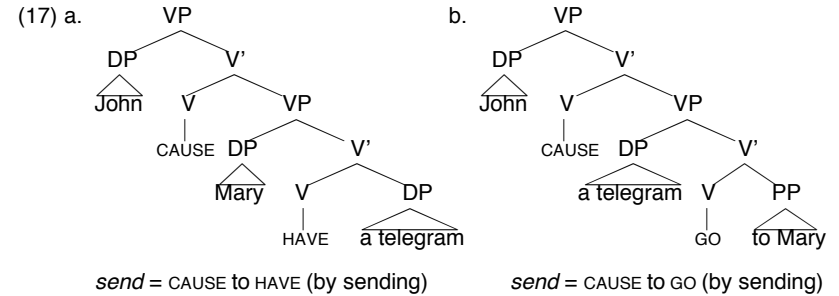

This analysis is supported by intuition and many distributional and semantic facts:

- one can conceive of *send* in two different ways:
  - (i) a means of bringing something into someone’s possession
  - (ii) a means of moving an object from one point to another
- this sense difference appears to correctly track distributional differences

When the PP object is not a potential possessor only oblique form is possible:

- (18) a. Pilar sent a telegram to **Lisbon**.  
 b. \*Pilar sent **Lisbon** a telegram.

Verbs like *distribute*, *disperse*, *donate*, *gave-away*, *gave-out*, *release*, *lose* seem to encode release or loss of possession, but no target possessor or recipient (19)/(20). Here too DO forms are blocked. Likewise for Vs like *drag* and *convey*, expressing physical or metaphorical motion along a path, and arguably no notion of possession at all (21)/(22):

- (19) a. John **distributed/dispersed/donated/gave-away/gave-out** money (to/among those charities).  
 b. \*John **distributed/dispersed/donated/gave-away/gave-out** those charities money.
- (20) a. John **lost** money to the stock market.  
 b. \*John **lost** the stock market money. (on the (20a) reading)
- (21) a. John **dragged** the chair (over) to Bill.  
 b. \*John **dragged** Bill (over) the chair.

- (22) a. John **conveyed** the visitors/the point to Bill.  
 b. \*John **conveyed** Bill the visitors/the point.

Rappaport Hovav and Levin (2008) note path modifiers (*halfway/all the way*) occur with *send* and *throw* in PP form (23a), but never in DO form (23b).

- (23) a. John threw a ball (**halfway/all the way**) to Mary.  
 b. John threw (**\*halfway/\*all the way**) Mary a ball (**\*halfway/\*all the way**).

There seem to be both discontinuous caused-motion idioms in the PP dative form with no double object counterparts (24a-d) (from Larson 1988), and discontinuous caused-possession idioms in the double object form with no PP dative counterparts:

- (24) a. Lasorda **sent** his starting pitcher **to the showers**.  
 (cf. \**Lasorda sent the showers his starting pitcher*.)  
 b. Mary **took** Felix **to the cleaners**.  
 (cf. \**Mary took the cleaners Felix*.)  
 c. Felix **threw** Oscar **to the wolves**.  
 (cf. \**Felix threw the wolves Oscar*.)  
 d. Max **carries** such behavior **to extremes**.  
 (cf. \**Max carries extremes such behavior*.)

- (25) a. John **gave** Mary **the creeps**.  
 (cf. \*?*John the creeps to Mary*.)  
 b. John **gave** Mary **flak**.  
 (cf. \*?*John gave flak to Mary*.)  
 c. John **gave** Mary **the boot**.  
 (cf. \*?*John gave the boot to Mary*.)

The surface-discontinuous items in (24) and (25) – if truly idioms – would appear to require distinct representations as initial constituents in underlying form (26a,b):

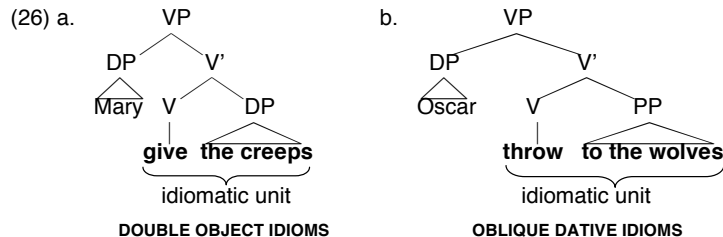

### 1.3 Separating Oblique Locatives from Oblique Possessives

These facts support separate projection for DO constructions encoding caused-possession and PP dative constructions encoding caused-motion/location.

**Question:** If we accept this, does it settle the question of dative projection altogether?

**Answer:** No !

RH&L argue for a further separation: between PP datives encoding caused-motion/location, and PP datives encoding caused-possession. I.e., they argue that PP dative form is polysemous.

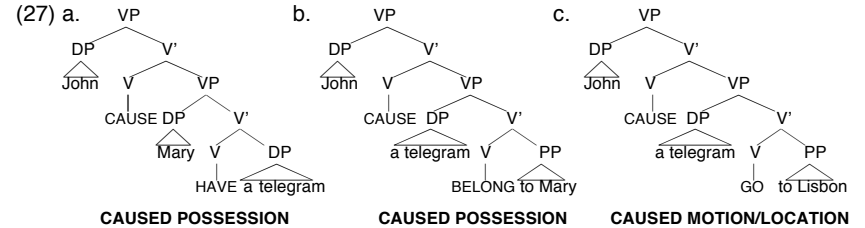

Corresponding to the 3-fold division of structures, RH&L offer a 3-fold division of Vs:

- (28) a. John dragged the chair to Bill. CAUSED MOTION  
 b. \*John dragged Bill the chair.
- (29) a. John gave a book to Mary. CAUSED POSSESSION  
 b. John gave Mary a book. CAUSED POSSESSION
- (30) a. John threw a ball to Mary. CAUSED MOTION or CAUSED POSSESSION  
 b. John threw Mary a book. CAUSED POSSESSION

#### Evidence:

i. Both DO and oblique *give* forms entail a corresponding possessive (31)/(32):

- (31) a. John gave Mary the book.  
 b. Mary had/got the book.  
 c. #John gave Mary the book, but she never got/received it.  
 d. #Pilar gave Lisbon the book.

- (32) a. John gave the book to Mary.  
 b. Mary had/got the book.  
 c. #John gave the book to Mary, but she never got/received it.  
 d. #Pilar gave the book to Lisbon.

ii. Whereas Vs of caused motion allow *to*-PPs with path modifiers, *give* and similar verbs reject such modifiers even in oblique form (33):

- (33) a. John dragged/threw/slid/sent the chair **halfway** to Bill.  
 b. \*John gave/handed/lent the ball **halfway** to Bill.  
 c. \*John gave/handed/lent /threw/slid/sent Bill the chair **halfway**.

iii. *to*-PPs can answer some *where*-questions with the Vs of caused motion, but not with Vs of caused possession (34). *Where*-questions are never felicitously answered with double object forms of Vs that can express both meanings (35):

- (34) a. Where did you **\*give/deposit/lose** your money?  
 (cf. *I deposited it in/to my checking account, I lost it in/to the stock market*.)

- b. Where did John **drag/throw/slide/send/ship** the chair?  
(cf. *John dragged/threw/slid/sent/shipped the chair (over) to Bill.*)

- (35) a. Where did John **send/ship/mail** the chair?  
b. ??John sent/shipped/mailed **Bill** the chair.

The idea that V<sub>s</sub> with oblique frames can express distinct possession and location senses is hard to resist Consider *belong*.

**Locative belong:** ‘object X is suitably, customarily or properly situated at location Y’.

- (36) a. This chair belongs **in the living room/halfway along that wall/there**.  
b. A: **Where** does this chair belong?  
B: It belongs **in there/\*to Mary**.  
c. John belongs in prison.  
d. Memories belong in the past.  
e. This information belongs in the public domain.

**Possessive belong:**

- (37) a. This chair belongs (**\*halfway**) **to Mary**.  
b. A: **To whom** does this chair belong?  
B: It belongs **\*in there/to Mary**.  
c. The book/fault/responsibility/credit belongs to John  
d. This piece belongs to that puzzle.

Given polysemy in oblique dyadic forms like *belong*, it seems reasonable to conjecture polysemy in oblique triadic forms like *throw* and *send*.

### Polysemy in P

The distinction between V<sub>s</sub> taking a *to*-PP appears to track a distinction in P itself.

**Dative to:** accompanies V<sub>s</sub> of caused possession  
**Directional/allative to:** accompanies V<sub>s</sub> of caused motion

European Portuguese appears to have distinct P<sub>s</sub>:

- (38) a. O João enviou uma carta **à** Maria/**para** a Maria  
the John sent a letter to Maria  
'John sent a letter to Maria'  
b. O João enviou uma carta **\*a** Lisboa/**para** a Lisboa  
the John sent a letter to Lisbon  
'John sent a letter to Lisbon'  
c. O João deu um livro **à** Maria/**\*para** a Maria  
the John gave a book to Maria  
'John gave a book to Maria'  
d. O João empurraram/arrastaram a mesa **\*à** Maria/**para** perto da Maria  
the John pushed/dragged a table to Maria/to the vicinity of Maria  
'John pushed/dragged a table to Maria'

Spanish shows a related alternation in the preposition *en* ‘on’:

- (39) a. María puso las patas **en** la mesa  
María put the legs on the table  
'Mary placed the legs upon the table' (locative meaning)  
'Mary attached the table's legs' (assembly meaning)  
b. María puso **las ranas** en la mesa  
María put the frogs on the table  
'Mary placed the frogs upon the table' (locative meaning)  
'#Mary attached the table's frogs' (assembly meaning)

- (40) a. María le puso las patas **a** la mesa  
María Cl-3Dat put the legs to the table  
'Mary attached the table's legs' (assembly meaning only)  
b. #María puso las ranas **a** la mesa  
María put the frogs to the table  
'#Mary attached the table's frogs' (assembly meaning only)

English suggests that this ambiguity resides in P itself

- (41) a. John put the wheels on the truck (ambiguous)  
b. The wheels are on the truck (ambiguous)  
c. The shipping containers are on the truck and the wheels are too. (unambiguous)

- (42) a. John dragged the chair to Bill. CAUSED MOTION Allative P  
b. John gave a book to Mary. CAUSED POSSESSION Dative P  
c. John threw a ball to Mary. CAUSED MOTION OR CAUSED POSSESSION Allative P Dative P

### Taking Stock:

- We have evidence that DO datives encoding caused possession and PP datives encoding caused motion/location are projected separately.
- We have evidence for a separate class of PP datives encoding caused possession.

**New Question:** What's the relation between PP and DO datives encoding caused possession? Are these derivationally related, or are they projected separately?

### 1.4 Dative Idioms Again

Are there idioms associated with the two types of possessives?

Notice that (24a-d) above are all irrelevant to this question since these are plainly caused motion forms:

- (24) a. Lasorda **sent** his starting pitcher **to the showers**.  
(cf. *\*Lasorda sent the showers his starting pitcher.*)  
b. Mary **took** Felix **to the cleaners**.  
(cf. *\*Mary took the cleaners Felix.*)  
c. Felix **threw** Oscar **to the wolves**.  
(cf. *\*Felix threw the wolves Oscar.*)  
d. Max **carries** such behavior **to extremes**.  
(cf. *\*Max carries extremes such behavior.*)

We must use verbs that strictly encode caused-possession, e.g., *give*:

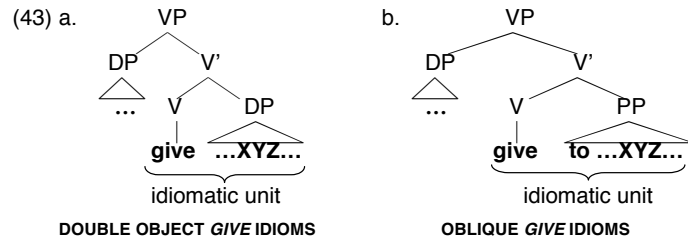

Are there such idioms??

**1.4.1 Oblique Give Idioms?**

Green (1974, pp.179) offers (44a.i-d.i) as oblique *give* idioms. The meanings of the constructions do appear unpredictable from the meanings of the parts. Furthermore DO variants are impossible (44a.ii-d.ii).

- (44) a.i. Mao's silence has **given rise** to an absurd rumor.
- ii. \*Mao's silence has **given** an absurd rumor **rise**.
- b.i. Sarah **gave birth** to a son.
- ii. \*Sarah **gave** a son **birth**.
- c.i. Activism **gave way** to apathy.
- ii. \*Activism **gave** apathy **way**.
- d.i. John **gave rein** to his feelings.
- ii. \*John **gave** his feelings **rein**.

But (44a-d) are not the sort of oblique idioms we are looking for. We want instances of (43b), where *give* and the oblique PP form a semantic unit. Here it's *give* and its adjacent nominal (*rise, birth, way, rein*) that do so.

it's not clear (44a.i-d.i) instantiate structure (43b) at all. The nominal appears inseparable from V:

- (45) a.i. \***Rise** has been **given** to an absurd rumor (by Mao's silence).
- ii. What has Mao's silence **given** to an absurd rumor?      Ans: \***Rise**.
- b.i. \***Birth** was given to a son (by Sarah).
- ii. What did Sarah **give** to a son?      Ans: \***Birth**.
- c.i. \***Way** was given to apathy (by activism).
- ii. What did activism **give** to apathy?      Ans: \***Way**.
- d.i. \***Rein** was **given** to his feelings (by John).
- ii. What did John **give** to his feelings?      Ans: \***Rein**.

Larson(1988) proposes (46) for these cases:

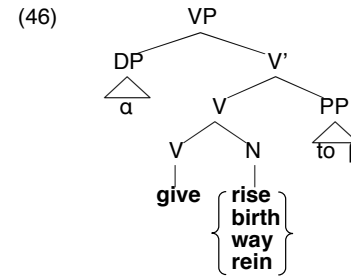

On this view, we are dealing with a series of distinct compound verbs (*give-rise, give-birth, etc.*), each with its own specific semantics.

**1.4.2 Double Object Give Idioms?**

Consider (47a.i.-f.i). These appear to involve *give* and a discontinuous theme. All are typically marginal to unacceptable in the PP construction (47a.ii.-f.ii).

- (47) a.i. John **gave** Mary **a strange feeling/the creeps**.
- ii. ?\*John **gave a strange feeling/the creeps** to Mary
- b. John **gave** Mary **a kiss/a kick/a shove**.
- ii. ?\*John **gave a kiss/a kick/a shove** to Mary.
- c.i. John **gave** Mary **flak**.
- ii. ?\*John **gave flak** to Mary.
- d. John **gave** Mary **a new idea/a ride**.
- ii. ?\*John **gave a new idea/a ride** to Mary.
- e.i. John **gave** Mary **a hand**.
- (cf. *John applauded Mary and John assisted Mary*)
- ii. ?\*John **gave a hand** to Mary.
- f.i. Dr. Jones **gave** Mary **a new arm** (using advanced surgical procedures).
- ii. ?\* Dr. Jones **gave a new arm** to Mary.

Green (1974) calls these “non-literal *give* expressions.” Are they idioms?

**Question 1:** What is an idiom?

Radford (1997): “We can define *idioms* as expressions...which have an idiosyncratic meaning that is not a purely componential function of their individual parts.”(p.159)

**Question 2:** Are the DO constructions in (47) non-compositional?

Consider first:

- (48) a. That dive gave me **the bends**.
- b. The view gave me **vertigo**.
- c. Students gave me **backtalk**.
- d. Alice gave me **a (cheery) wave**.
- e. My landlord gave me **two week's notice**.



We're assuming *give*, in both its DO and PP forms means 'cause to possess or receive'. Assume the mapping in (49):

(49) [<sub>VP</sub> *give* DP<sub>1</sub> DP<sub>2</sub>] → 'cause DP<sub>1</sub> to have/get DP<sub>2</sub>'

Regarding the boldfaced nominals in (48), *Webster's Seventh New Collegiate Dictionary* provides the subentries in (50a-e) (respectively):

- (50) a. **bend** n...3: *pl but sing or pl in construction* caisson disease.  
**caisson disease** n : a sometimes fatal disorder marked by neuralgic pains and paralysis and caused by too rapid decrease in air pressure after a stay in compressed atmosphere – also called *bends*.  
 b. **vertigo** n **1a**: a disordered state in which the individual or his environs seem to whirl dizzily...  
 c. **backtalk** n **1a**: an impudent, insolent or argumentative reply  
 d. **wave** n...4: a sweep of hand or arm or of some object held in the hand used as a signal or greeting  
 e. **notice** n...1a...(3): notification by one of the parties to an agreement or relation of intention of terminating it at a specified time.

Taking (49) and (50) together, we compute the results in (51a-e) for (48a-e) (adjusting for tense and suppressing irrelevant details):

- (51) a. *gave me the bends*: 'caused me to have a disorder marked by neuralgic pains and paralysis and caused by too rapid decrease in air pressure after a stay in compressed atmosphere'  
 b. *gave me vertigo*: 'caused me to have a disordered state in which I or my environs seemed to whirl dizzily'  
 c. *gave me backtalk*: 'caused me to get an impudent, insolent or argumentative reply'  
 d. *gave me a wave*: 'caused me to get a sweep of hand or arm or of some object held in the hand used as a signal or greeting'  
 e. *gave me two week's notice*: 'caused me to have notification as the party to an agreement or relation of intention of terminating in two week's time'

These are the meanings of the expressions in question. So (48a-e) are compositional and hence non-idiomatic.

Consider now (52a-d), discussed in Larson (1988), and widely cited as clear instances of dative idioms of the double object form (43a) (Pesetsky 1995; Richards 2001; Harley 2002). If so they should be non-compositional, unlike (48a-e).

- (52) a. The Count gave me **the creeps**.  
 b. John gave Mary **flak** (about/during her presentation).  
 c. His boss gave Max **the boot**.  
 d. Moe gave Larry **the finger**.  
 e. Alice gave me **a piece of her mind**.

*Webster's Seventh New Collegiate Dictionary* (WSNCD) and *The American Heritage Dictionary of The English Language* (AHDEL) yield (53a-e) for the boldfaced nominals in (52a-e):

- (53) a. **creep** n **1**: a movement of or like creeping **2**: a distressing sensation like that caused by the creeping of insects over one's flesh; esp a feeling of apprehension or horror – usu. used in the plural. (WSNCD)  
 b. **flak** n...2 Informal **a**. Excessive or abusive criticism. **b**. Dissent, opposition. (AHDEL)  
 c. **boot** n...6 Brit a blow delivered by or as if by a booted foot: KICK; also : a rude discharge or dismissal. (WSNCD)  
 d. **finger** n...6 an obscene gesture of defiance or derision made by pointing or jabbing the middle finger upward. (AHDEL)  
 e. **piece** n...-idioms **a piece of (one's) mind** Frank and severe criticism; censure. (AHDEL)

Using (49) again, we compute the results in (54) (adjusting for tense and suppressing irrelevant details):

- (54) a. *gave me the creeps*: 'caused me to have a feeling of apprehension or horror'  
 b. *gave Mary flak*: 'caused Mary to have/get excessive or abusive criticism'  
 c. *gave Max the boot*: 'caused Max to have/get a rude dismissal'  
 d. *gave Larry the finger*: 'caused Larry to have/get an obscene gesture of defiance or derision made by pointing or jabbing the middle finger upward'  
 e. *gave me a piece of her mind*: 'caused me to receive frank and severe criticism; censure'

These are the meanings of the expressions in question. So (48a-e) are compositional and hence non-idiomatic.

This conclusion seems inevitable. The nominal in *give ~ the creeps* can be elaborated and modified in regular ways comparable to *the bends*, *the measles*, etc. (55). Compare true idioms (56)

- (55) a. The Count gave me **an amazingly bad and violent case of the creeps/a case of the creeps that lasted for weeks/creeps that I just couldn't shake**.  
 b. That dive gave me **an amazingly bad and violent case of the bends/a case of the bends that lasted for weeks/bends that damn near killed me**.  
 c. My trip abroad gave me **an amazingly bad and violent case of the measles/a case of the measles that lasted for weeks/measles that covered my body**.

(56) The **thick** fur flew/The shit hit the **whirling** fan/John kicked the **big** bucket.

Genuine idioms typically resist substitution of sub-parts, even by elements of similar sense, on pain of reverting to literal meaning (57a-d). Compare *give ~ the creeps* (58).

- (57) a. The cat got out of the **bag/sack/tote/pouch**.  
 b. The **fur/hair** flew.  
 c. The shit **hit/struck/collided** with the fan.  
 d. John kicked the **bucket/pail**.

(58) The Count gives me **the creeps/the willies/the shivers/the shakes/the chills/the jitters/goosebumps/gooseflesh/the fits/the heebie-jeebies/the screamin' meemies**.

These results seem compatible with the basic view of Larson (1988) that the sense of idiomaticity here resides in the nominal. Our results with *give ~ the creeps* appear quite general.

- (59) a. John **gave** Mary **flak** (about/during her presentation).  
 b. John gave Mary **a lot of flak/ far more flak than anyone had expected**.  
 c. John gave Mary **flak/static/shit/crap/hassle/trouble**.
- (60) a. John **gave** Mary **the boot**.  
 b. John gave Mary **the royal order of the boot**.  
 c. We will all be **for the boot** by Friday.  
 d. John gave Mary **the boot/the sack/the chop**.

**Conclusion:** None of these cases constitute genuine double object idioms. There appear to be no *give*-idioms of either the oblique or double object form in the caused-possession meaning, and hence no evidence for separate projection from this source.

#### 1.4.3 Double Object Forms Without Oblique Variants?

**Question:** If (47a.i.-f.i) aren't idioms, then why are their PP variants marginal/unacceptable? What directs them to one structure vs. the other?

Corpus research discussed in RH & L shows that such examples occur far more frequently in PP form than is typically assumed.

Green (1974) already observed that the situation was more complicated than usually acknowledged. In contexts of relativization (61), question formation (62), and "heavy" to-PPs (63), oblique forms become available:

- (61) a. The infection that Martha gave to John nearly killed him.  
 b. The shove that Liz gave to Richard shocked us all.  
 c. The flak that Joan gave to Ed utterly decimated him.  
 d. The idea that Bill gave to Sue caused her to rewrite her thesis.  
 e. The ride Mack gave to Ellen ended in disaster. (= Green (1974, p177, 28a-e))
- (62) a. What kind of infection did Martha give to John?  
 b. How hard a shove did Liz give to Richard anyway?  
 c. What sort of flak did Joan give to Ed?  
 d. Which idea did Bill give to Sue?  
 e. How long a ride did Mack give to Ellen? (= Green (1974, p177, 29a-e))
- (63) a. The Snopes brats gave the mumps [to every single kid who lived within two blocks of them].  
 b. He threatened to give a beating [to anyone who attempted to reveal where they had been].  
 c. We gave the peace sign [to all of the American soldiers we saw].  
 d. They gave an idea [to all of us who had read the assignments faithfully].
- (64) a. Mary gave John **the flu/the finger/the answer**, and then she gave **it** to Bill.  
 b. ??Then she gave **the flu/the finger/the answer** to Bill.  
 (cf. Green (1974, p170, 4-6))

Green's conclusion: the constraints in (61)-(64) are "surface realizational". The oblique form becomes available where the double object form or derivatives of it are disfavored or excluded by independent constraints.

- (65) a. \*Mary gave John **the flu/the finger/the answer**, and then she gave Bill **it**.  
 b. They gave **it** to John.  
 c. \*They gave John **it**.
- (66) a. The Snopes brats **gave** [every single kid who lived within two blocks of them] **the mumps**.  
 b. He threatened to **give** [anyone who attempted to reveal where they had been] **a beating**.  
 c. We **gave** [all of the American soldiers we saw] **the peace sign**.  
 d. They **gave** [all of us who had read the assignments faithfully] **an idea**.  
 e. We **gave** [each of the crying, ragged, long-neglected children] **a ride**.  
 (= Green (1974, p174-175, 23a-g))
- (67) a. \*The Snopes brats **gave the mumps** [every single kid who lived within two blocks of them].  
 b. \*He threatened to **give a beating** [anyone who attempted to reveal where they had been].  
 c. \*We **gave the peace sign** [all of the American soldiers we saw].  
 d. \*They **gave an idea** [all of us who had read the assignments faithfully].  
 e. \*We **gave a ride** [each of the crying, ragged, long-neglected children].  
 (= Green (1974, p175, 24a-g))

#### 1.4.4 Languages without Double Object Forms

Green's view has implications for languages that lack the DO construction. If DO and PP dative forms both encode the same meaning, and the restrictions in (47) arise from surface constraints, suspended when the double object form is unavailable (or when the relevant restrictions cannot be locally detected), we might expect the counterparts of (47a-f) to emerge unhindered in the oblique form.

- (68) a. O João deu um livro **à** Maria/\***para** a Maria (European Portuguese)  
 the John gave a book to Maria  
 'John gave a book to Maria'  
 b. O João enviou uma carta **à** Maria/**para** a Maria  
 the John sent a letter to Maria  
 'John sent a letter to Maria'  
 c. O João enviou uma carta **\*a** Lisboa/**para** a Lisboa  
 the John sent a letter to Lisbon  
 'John sent a letter to Lisbon'
- (69) a. \*O João deu **a** Maria um livro  
 the John gave the Maria a book  
 'John gave Maria a book'  
 b. \*O João deu **à** Maria um livro  
 the John gave to-the Maria a book  
 'John sent to Maria a letter'

- c. Susana **le<sub>i</sub>** mandó **a Pablo<sub>i</sub>** una carta  
Susana **him.cl.Dat** sent to Pablo a letter  
'Susana sent a letter to Paul' (Spanish)
- d. Susana **le<sub>i</sub>** mandó una carta **a Pablo<sub>i</sub>** (Spanish)

European Portuguese exhibits a wide variety of non-literal *give* constructions equivalent to those in (47):

- (70) a. A Maria **deu** banho **ao João**.  
the Maria gave bath to-the John  
'Maria gave John a bath' (cf. *?\*Maria gave a bath to John*)
- b. A Maria **deu** uma pintadela **à grade**  
the Maria gave a quick paint to-the fence  
'Maria gave the fence a quick painting'  
(cf. *?\*Maria gave a quick painting to the fence*)
- c. A Maria **deu** uma olhadela **ao livro**. / **deu** um empurrão **ao Pedro**.  
the Mary gave a look to-the book gave a push to-the Peter  
'Mary gave the book a look/gave Peter a push'
- d. A Maria **deu** uma mão **ao Pedro**.  
the Mary gave a hand to-the Peter  
'Mary gave Peter a hand'
- e. A Maria não **dá** bola **ao Pedro**.  
the Mary not give boll to-the Peter  
'Mary doesn't give a shit about Peter'
- f. Ele **deu** a volta **à Maria**  
he gave the turn to-the Maria  
'He convinced Maria'
- g. O Pedro **deu** para trás **à Maria**  
the Pedor gave for back to-the Maria  
'Peter contradicted Mary, didn't support Mary'
- h. Isso **dá** jeito **à Maria**  
that gives hand to-the Maria  
'That comes in handy to Maria'
- i. De repente, **deu** uma coisa **à Maria** e começou a insultar toda a gente.  
of sudden gave one thing to-the Mary and she started to insult all the people  
'Suddenly, something hit Mary [in the figurative sense], and she started to insult everybody.'

This line of thinking extends beyond triadic constructions to simple possessives.

- (71) a. **Chulsu-ege** cek-i itta Korean  
Chulsu- Dat book-Nom be  
'Chulsu has a book'
- b. **Chulsu-ege** (coeun) sangkak-i itta  
Chulsu-Dat good idea-Nom be  
'Chulsu has a good idea.'
- c. **Chulsu-ege** munjae-ga itta  
Chulsu-Dat problem-Nom be  
'Chulsu has a problem.'
- d. **Chulsu-ege** yel-i itta  
Chulsu-Dat fever-Nom be  
'Chulsu has a fever.'

- (72) a. **John-ni** wa kangae-ga aru. Japanese  
John-Dat. top. idea-Nom be  
'John has an idea'
- b. **John-ni** wa netu-ga aru.  
John-Dat top fever-Nom be  
'John has fever.'

### 1.5 Recasting the Problem Area: Applicative Constructions

Where we are?

- DO forms associate with one meaning (caused-possession)
- PP forms associate with at least two meanings (caused-possession, caused-motion/location).
- Solid evidence to think caused-possession and caused-motion constructions are projected separately.
- No evidence for projecting the two caused-possession structures separately

**Question:** What is the relation between the two caused possession structures?

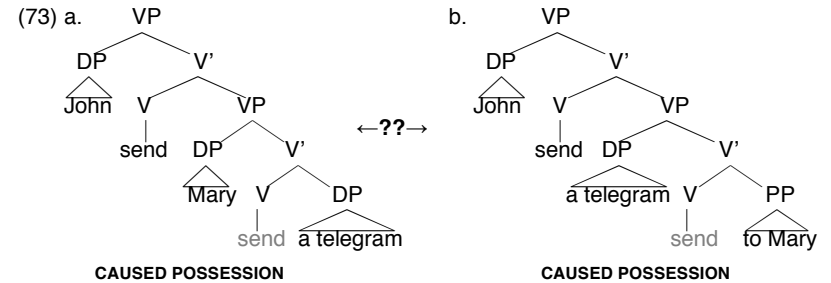

**Question:** What ties DO form to caused possession? If PP form can encode both meanings, why can't DO form?

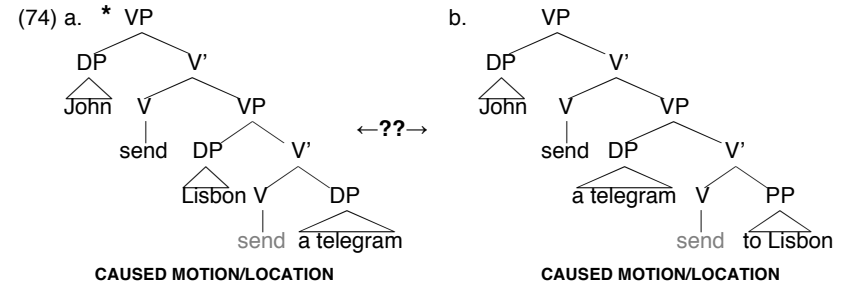

**Applicative constructions** appears to offer crucial insight.

- (75) a. Mbidzi zi-na-perek-er-a **APPLIED OBJ nkhandwe** **BASE OBJ msampha**  
zebras SP-PST-hand-APP-ASP fox trap  
‘The zebras handed the fox the trap’ (= (3a) Baker 1988, p. 229)  
b. Mbidzi zi-na-perek-a msampha kwa nkhandwe  
zebras SP-PST-hand-ASP trap to fox  
‘The zebras handed the trap to the fox’ (= (2a) Baker 1988, p. 229)
- (76) Kalulu a-na-gul-ir-a mbidzi nsapato  
hare SP-PST-buy-APP-ASP zebras shoes  
‘The hare bought the zebras shoes’ (= (46a) Baker 1988, p. 240)
- (77) Mavuto a-na-umb-ir-a mfumu mtsuko  
Mavuto SP-PST-mold-APP-ASP chief waterpot  
‘Mavuto molded the chief the waterpot’ (= (141a) Baker 1988, p. 290)
- (78) a. John was bought \_\_\_ those shoes.  
b. \*The shoes were bought John \_\_\_.
- (79) a. \*[Who John bought \_\_\_ those shoes] was Mary.  
b. [What John bought Mary \_\_\_] was those shoes.
- (80) a. Mbidzi zi-na-gul-ir-idw-a nsapato (ndi kalulu)  
zebras SP-PST-buy-APP-PASS-ASP shoes by hare  
‘The zebras were bought shoes (by the hare)’ (= (46b) Baker 1988, p. 240)  
b. \*Nsapato zi-na-gul-ir-idw-a mbidzi (ndi kalulu)  
shoes SP-PST-buy-APP-PASS-ASP zebras by hare  
‘The shoes were bought for zebras (by the hare)’ (= (47) Baker 1988, p. 240)
- (81) a. \*Iyi ndiyo mfumu imene ndi-ku-ganiz-a M. a-na-umb-ir-a mtsuko  
this is chief which 1SS-PRES-think-ASP Mavuto SP-PST-mold-APP-ASP waterpot  
‘This is the chief that I think Mavuto molded the waterpot for’  
(= (141b) Baker 1988, p. 290)  
b. Uwu ndiyo mtsuko umene ndi-ku-ganiz-a Mavuto a-na-umb-ir-a mfumu  
this is waterpot which 1SS-PRES-think-ASP Mavuto SP-PST-mold-APP-ASP chief  
‘This is the waterpot that I think Mavuto molded for the chief’  
(= (143) Baker 1988, p. 290)

### 1.5.1 The Semantic Range of Applicatives

English DOs are restricted to cases like (75a) and (76), where the applied object has the thematic status of recipient-goal:

- (82) a. \*John put the table the key.  
b. John put the key on the table.
- (83) a. John baked the cake for Mary.  
i. ‘John baked the cake for Mary to have.’  
ii. ‘John baked the cake as a favor to Mary/at her request.’  
iii. ‘John baked the cake in Mary’s place, as a substitute for her.’

- b. John baked Mary the cake.  
i. ‘John baked the cake for Mary to have.’  
ii. #‘John baked the cake as a favor to Mary/at her request.’  
iii. #‘John baked the cake in Mary’s place, as a substitute for her.’

Applicative constructions do not share this restriction. They exhibit a much wider range of senses than English:

- (84) a. ni θáy -ətc -θ -ámʔš -əs ʔə kʷθə nə-snəxʷəʔ **Halkomelem**  
AUX fix -APP -TR -1O -3A OBL Det 1POS-canoe  
‘He fixed my canoe for me’ (= (2.71) Farrell 2005, p. 85)  
b. Kambuku a-na-b-er-a mkango njinga **Chichewa**  
leopard SP-PST-steal-APP-ASP lion bicycle  
‘The leopard stole the bicycle from/on the lion’ (= (28b) Baker 1988, p. 240)
- (85) a. Fisi a-na-dul-ir-a mpeni chingwe **Chichewa**  
hyena SP-PST-cut-APP-ASP knife rope  
‘the hyena cut the rope with the knife’ (= (22b) Baker 1988, p. 238)  
b. Fisi a-na-dul-a chingwe ndi mpeni  
hyena SP-PST-cut-ASP rope with knife  
‘the hyena cut the rope with the knife’ (= (22a) Baker 1988, p. 238)
- (86) a. Umwaana y-a-taa-ye-mo amaazi igitabo **Kinyarwanda**  
child SP-PST-throw-ASP-APP water book  
‘The child threw the book into the water’ (= (26b) Baker 1988, p. 239)  
b. Umwaana y-a-taa-ye igitabo mu maazi  
child SP-PST-throw-ASP book in water  
‘The child threw the book into the water’ (= (26a) Baker 1988, p. 238)
- (87) a. Umugore y-oohere-je-ho -iisoko umubooyi **Kinyarwanda**  
woman SP-send-ASP-APP market cook  
‘The woman sent the cook to the market’ (= (27b) Baker 1988, p. 239)  
b. Umugore y-oohere-je umubooyi kw’ -iisoko  
woman SP-send-ASP cook to market  
‘The woman sent the cook to the market’ (= (27a) Baker 1988, p. 239)
- (88) a. ni cən c’əq’ -méʔ kʷθə sqʷəməy **Halkomelem**  
AUX 1SUBJ astonished -APP Det dog  
‘I was astonished at the dog’ (= (2.72d) Farrell 2005, p.86)  
b. ni cən c’əq’ ʔə kʷθə sxəkʷs  
AUX 1SUBJ astonished OBL Det carving  
‘I was astonished at his carving’ (= (2.72a) Farrell 2005, p.86)

- (89) a. Umugabo a-ra-som-an-a ibaruwa ibyiishiimo **Kinyarwanda**  
 man SP-PRES-read-APP-ASP letter joy  
 'The man is reading a letter with joy' (= (ib) Baker 1988, p. 468)  
 b. Umugabo a-ra-som-a ibaruwa n' -ibyiishiimo  
 man SP-PRES-read-APP-ASP letter with joy  
 'The man is reading a letter with joy' (= (ia) Baker 1988, p. 467)
- (90) Nsima iyi ndi-ku-dy-er-a njala **Kinyarwanda**  
 cornmealthis 1sS-PRES-eat-APP-ASP hunger  
 'I am eating this cornmeal form/because of hunger' (= (ii) Baker 1988, p. 468)

**Question:** What ties DO form to caused possession?

**Answer:** Nothing. DO form is not tied to caused possession. The appearance is simply a parochial fact about English.

### 1.5.2 The Morphological Form of Applicative Constructions

Applicatives typically show a specific verbal affix, glossed APP, that accompanies the form (91). Baker argues that examples like (92) contain a null applicative affix.

- (91) a. Ngombe zi-na-tumiz-ir-a mbuzi mitolo ya udzu  
 cows SP-PRES-send-APP-ASP goats bundles of grass  
 'The cows sent the goats bundles of grass' (= (121b) Baker 1988, p. 281)  
 b. Ngombe zi-na-tumiz-a mitolo ya udzu kwa mbuzi  
 cows SP-PRES-send-ASP bundles of grass to goats  
 'The cows send bundles of grass to the goats' (= (121a) Baker 1988, p. 280)
- (92) a. Joni a-na-pats-a amai ake nthochi  
 John SP-PRES-give-ASP mother his bananas  
 'John gave his mother the bananas' (= (122b) Baker 1988, p. 281)  
 a. Joni a-na-pats-a nthochi kwa amai ake  
 John SP-PRES-give-ASP bananas to mother his  
 'John gave the bananas to his mother' (= (122a) Baker 1988, p. 281)

**Question:** What's the relation between the two (Engl) caused possession structures?

**Revised Question:** What's the nature of applicative-oblique alternation? How are the two constructions related?

(93)	<b>Applicative</b>		<b>Oblique</b>
	<b>Form:</b> α V-APP β γ	←??→	α V γ [P β]
	<b>Senses:</b> CAUSED POSSESSION		CAUSED POSSESSION
	BENEFACTIVE/MALEFACTIVE/		BENEFACTIVE/MALEFACTIVE/
	SUBSTITUTIVE		SUBSTITUTIVE
	INSTRUMENTAL		INSTRUMENTAL
	CAUSED MOTION/LOCATION		CAUSED MOTION/LOCATION
	STIMULATIVE		STIMULATIVE
	MANNER		MANNER
	REASON		REASON

## 2.0 Derivational Approaches to the Dative Alternation

The idea of a derivational relation between English prepositional and double object datives dates back to Chomsky (1955/1975, p.493). The unavailability of question formation in (94b) versus (94c) "...suggests there is a sentence more elementary than [94a], namely, [94d], and that [94a] is derived from [94d] by a transformation T<sub>α</sub>."

- (94) a. The teacher gave him several books. (= (235a) in Chomsky (1975))  
 b. \*Whom did the teacher give the books? (= (239a) in Chomsky (1975))  
 c. Whom did the teacher give the books to? (= (240a) in Chomsky (1975))  
 d. The teacher gave several books to him. (= (241) in Chomsky (1975))

"It seems to be true in general that for sentences of the form NP<sub>1</sub>-V-NP<sub>2</sub>-to/for-NP<sub>3</sub> there is a related form NP<sub>1</sub>-V-NP<sub>3</sub>-NP<sub>2</sub>... We must then require that the *who*-question transformation not apply to any T<sub>α</sub>-transform, in order to eliminate [94b]."

"Dative Shift" or "Dative Movement" was subsequently investigated by Filmore (1965) and Green (1974) in major works, and by Emonds (1972), Jackendoff and Culicover (1971), and Fischer (1972), among many others. Also frequently discussed in textbooks of the period (Burt 1971, Akamajian and Heny 1976, Baker 1977, Culicover 1976, Jacobs and Rosenbaum 1968, Keyser and Postal 1976).

Derivational connection was also widely pursued in Relational Grammar (RG).

**Passive:** 2 to 1 advancement  
**Dative Shift:** 3 to 2 advancement

RG and EST differed in interesting ways.

- (95) Col. Mustard killed the victim [for **Prof. Plum**] [in **the conservatory**]  
 [with **the rope**].

**EST:** the bracketed phrases are non-thematic "adjuncts"; the boldfaced nominals are inaccessible to A-movement operations (Passive, Raising).

**RG:** the boldfaced nominals bear "oblique grammatical relations" like Benefactive (BEN), Locative (LOC) and Instrument (INSTR). This allows for relation changing rules like BEN → 2, LOC → 2, INSTR → 2, etc. More generally OBLIQUE → 2.

### 2.1 Larson (1988) OBL → 2 as A-Movement

Challenges:

- Indirect objects in DO forms plainly occupy A(argument)-positions. Hence a derivational theory of DO forms must involve A-movement
- In GB, A-movement was exemplified by Passive and Raising; displacement from a caseless, thematic position (subject, object) and to a case-marked, non-thematic position.

On any theory taking DO form to derive from PP form, indirect objects will originate in PP object position, which is not caseless:

(96) John gave Mary a book [to Mary]

Also: since movement is possible only to an empty site, Dative Shift requires an empty object position. But object positions were assumed to be licensed strictly by the θ-requirements of V. The “Projection Principle” required θ-positions to be occupied at D-structure. Hence no empty object positions!

**Case:** Assume Dative Shift “absorbs” P the way Passive absorbs accusative case.

**Empty Position:** Generalize the logic of RG and EST for Passive

(97) a. John kissed Mary  
 b. (was) kissed Mary [by John] **Agent Postposing**  
 c. Mary (was) kissed [by John] **Object Preposing**

(98) a. John kissed Mary (John initial 1; Mary initial 2)  
 b. kissed Mary by John (John chomeur; Mary 2) “demotion”  
 c. Mary was kissed by John (John chomeur; Mary final 1) 2 → 1

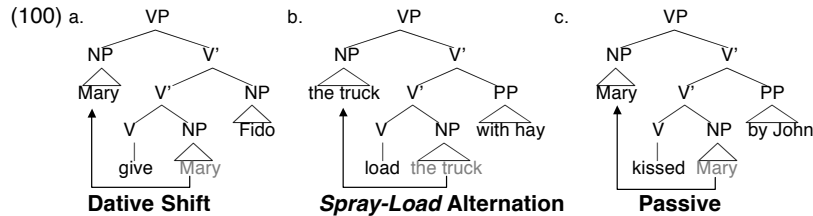
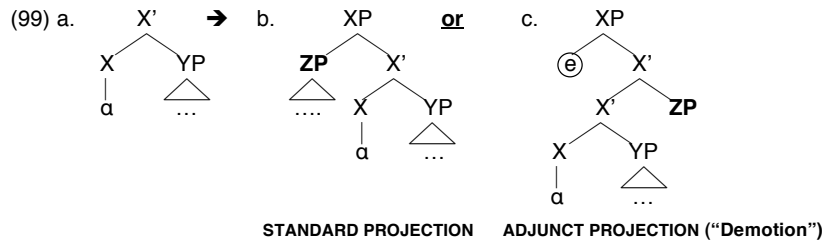

**2.3 Problems and Questions**

The idea that *to*-suppression in Dative Shift was a version of case-suppression in Passive, however natural in 1988, did not become clearer. It also wasn't clear it extended to English *for*-dative alternations like (101a,b):

(101)a. John baked a cake for Mary  
 b. John baked Mary a cake.  
 c. John baked a cake.

Nor was it clear how to extend the analysis to the more exotic OBL → 2 advancements found in applicative languages

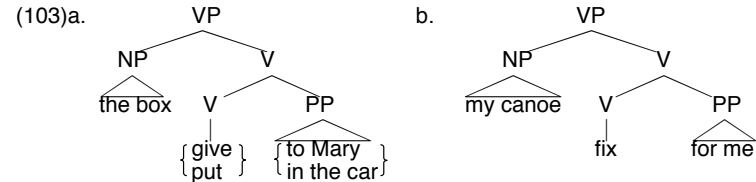
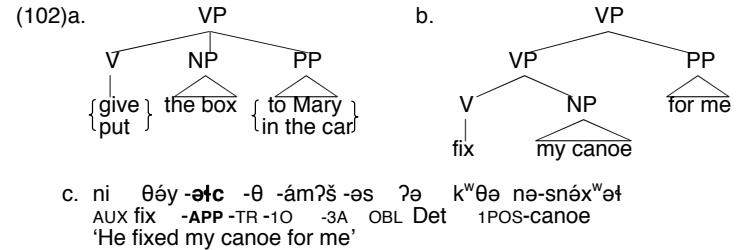

Most problematic: analysis of the landing site for Dative Movement heavily depended on X-bar theory, in the form of a specific stipulated Adjunct Projection template. Chomsky's (1994) convincingly eliminated independent, templatic X-bar theory in favor of a strictly compositional, “minimalist” account of structure-building.

**2.4 Other Derivational Accounts**

**2.4.1 Baker (1988)**

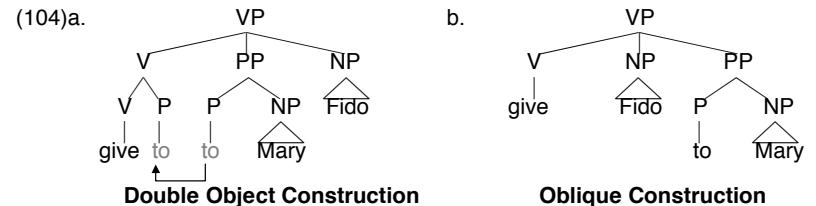

**Problems/Questions:** flat structures, c-command relations

2.4.2 Baker (1996b)

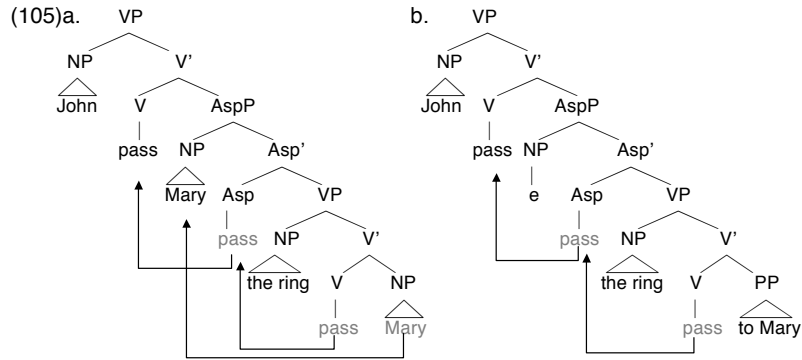

Double Object Construction

Oblique Construction

Problems/Questions: Minimality?

2.4.3 Zushi (1992)

(106)a. John-ga Mary-ni hon-o ageta  
 John-NOM Mary-DAT book-ACC gave  
 'John gave Mary a book'

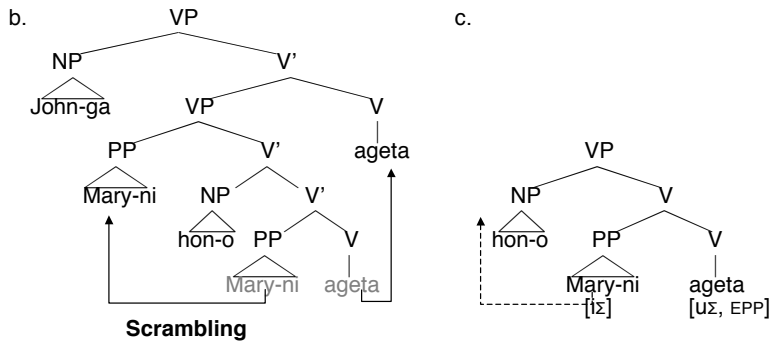

Scrambling

2.4.4 Den Dikken (1995)/Oba (2002)

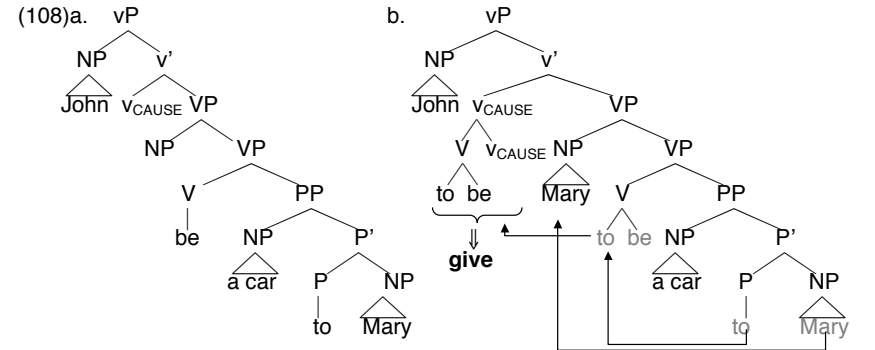
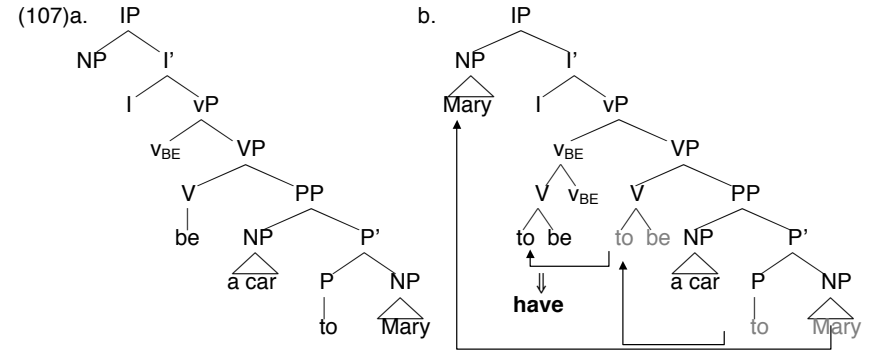

Problems/Questions: Is this extnsible to the full range of applicatives??

- (109) a. Fisi a-na-dul-a chingwe ndi mpeni  
 hyena SP-PST-cut-ASP rope with knife  
 'the hyena cut the rope with the knife' (=22a) Baker 1988, p. 238
- b. Fisi a-na-dul-ir-a mpeni chingwe  
 hyena SP-PST-cut-APP-ASP knife rope  
 'the hyena cut the rope with the knife' (=22b) Baker 1988, p. 238

- (110)a. John opened [the safety deposit box] [with his key].
- b. \*John opened [his key] [the safety deposit box].

- (111)a. The safety deposit box opened with John's key.
- b. John's key opened the safety deposit box.

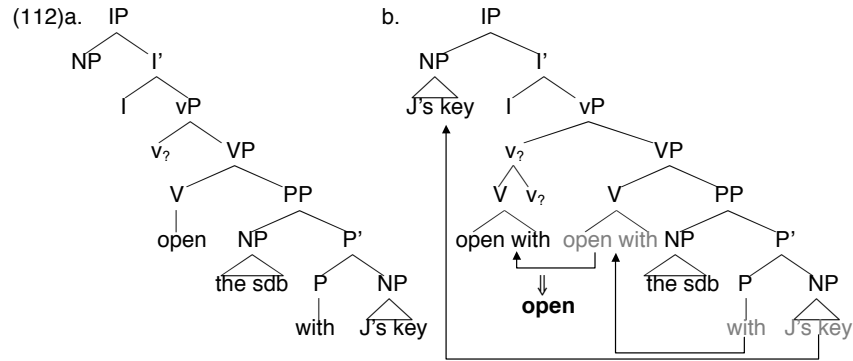

## Summary

- There is ample evidence for thinking DO caused possession and PP caused motion structures project separately (i.e., aren't derivationally related)
- There is no evidence for thinking DO caused possession and PP caused possession structures project separately
- widely cited arguments from “DO idioms” are simply mistaken
- applicative structures generalize the question of relatedness in a revealing way: as a question of broad parallelism between applicatives and obliques.
- we looked at various derivational analyses of the English DO structure and various problems with them

## Next time:

An extension of the  $\theta$ -features account to voice alternation, and a discussion of case

Thank you!



# θ-features and Projection: Lecture 3

Richard Larson (Stony Brook University)

Where we are:

- We sketched an account of projection based on θ-roles construed as features and θ-role assignment construed as feature agreement.
- We reviewed dative projection finding it a subcase of applicative-oblique alternation. Grammar appears to make available two structural possibilities for expression of essentially the same broad content.
- We reviewed derivational approaches to the dative-oblique relation and various points arising in connection with them.

Where we will go today:

- A derivational account of voice alternations, including passive and applicative-oblique.
- Application of these ideas in DP.

## 1.0 Voice Alternation

**Key idea:** oblique-applicative alternation results from a formal option present in the mechanisms of syntactic structure building, and which is the basis of voice alternation generally, including not only dative/applicative alternations, but also passives.

### 1.1 Little v and P

We considered *Mary give Fido to John*, involving three arguments. V bears at most a single valued θ-feature - [TH] as default. All other valuation requires independent elements. The preposition *to* values [GL] under agreement with *Mary*. Little v values [AG] under agreement with *John* (1):

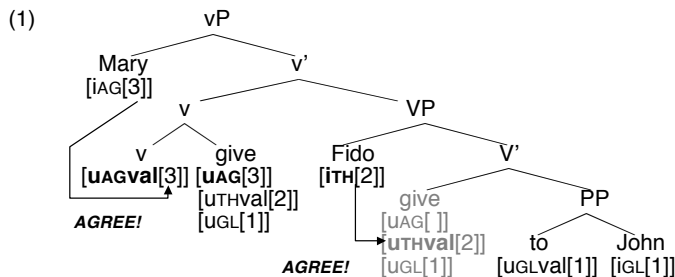

This picture establishes a certain equivalence between v and P: both can value θ-features:

$$(2) \quad \begin{matrix} v & P \\ [u\theta val[ \ ]] & \Leftrightarrow [u\theta val[ \ ]] \end{matrix}$$

This equivalence suggests alternative derivational possibilities. Other things being equal, we might expect alternative derivations in which:

- P values the agent feature ([AG]) instead of little v
- little v values the goal feature ([GL]) instead of P.

### 1.2 Passive

We saw that simple external merge of an agent phrase *Mary* to a transitive VP like *kiss John* will not yield an interface legible object; [AG] is unvalued (3a). We introduced a voice head bearing valued [AG] (3b):

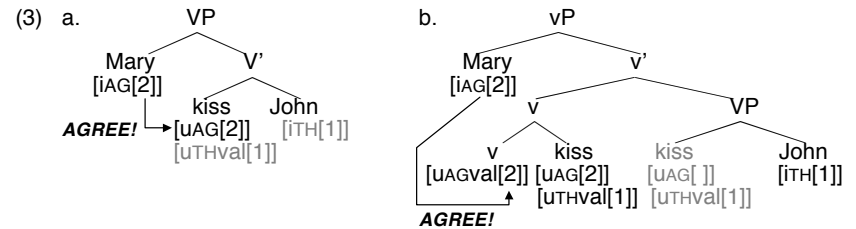

**Alternative possibility:** Suppose *by* can bear valued [AG]. In place of (3), we could have (4), first merging *John* with *by*, and then merging the result with *kiss Mary*, in both cases under agreement with [AG]

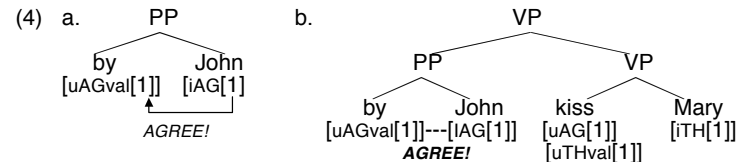

In (4b) all θ-features are properly valued. Nonetheless, the resulting sentence is not well-formed. *By John kisses Mary* is not a licit alternative to the transitive *John kisses Mary*.

**Suggestion:** (4b) is excluded for case reasons. Suppose T bears a NOM feature and little v bears ACC (Chomsky 1995). In typical transitives like (5), *Mary* is local to T and *John* is local to v. Agreement for case is straightforward:

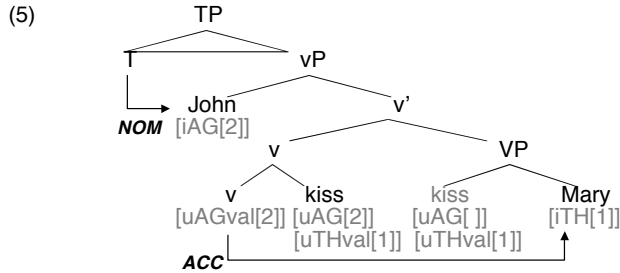

Not so, however, with (6). PP intervenes between T and *Mary*, T finds no case-goal to agree with and no other local case probe is available to *Mary*. The derivation fails on case theoretic grounds.

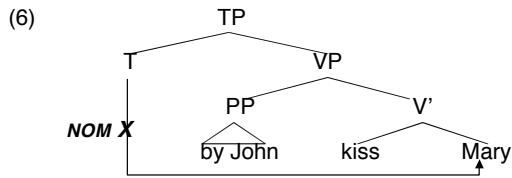

**Another Thought Experiment:** Suppose [TH] on V could be “devalued” so that the set of θ-features for *kiss* became {[uAG[]], [uTH[]]}. Merge with *Mary* now yields an interpretable but unvalued feature (7a). But since [TH] is unvalued on *kiss*, we can co-select a voice head bearing a valued [TH]. Merger with VP and V raising yields (7b).

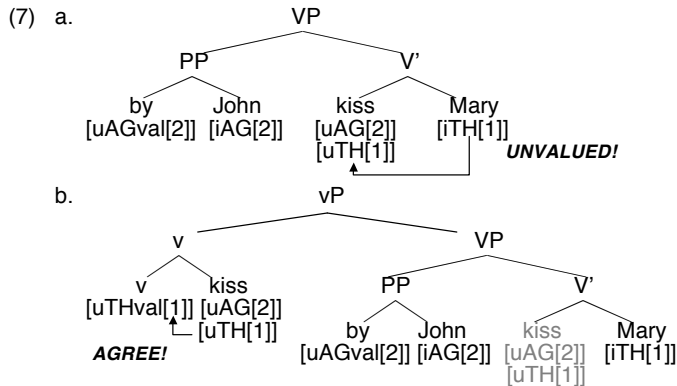

**NB!** In (7b), *kiss* agrees with *Mary* on [TH]. Also, little *v* agrees with *kiss* on [TH]. It follows that little *v* agrees with *Mary* on [TH]. Since *Mary* and little *v* agree, *v* can activate its EEP feature, raising the theme to Spec across the *by*-phrase (8):

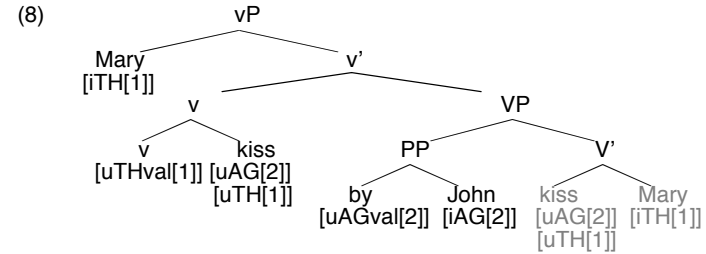

Transitivity of agreement + the fact that *Mary* has already undergone agreement with *kiss* conspire to circumvent minimality, which would otherwise block a higher probe (here *v*) from agreeing with and raising a lower goal (here *Mary*) across an intervening phrase of the same featural type (here *by John*).

In (8), no case problems occur. *Mary* is local to T and can raise further to TP Spec, etc. (9). *John* undergoes case agreement with *by* in the usual way:

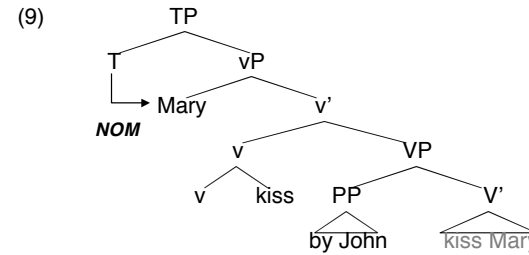

**Suggestion:** This is the derivation of passives. For concreteness, take passive morphology to “devalue” [TH] on V (10):

(10) **Passive:** 
$$\begin{matrix} V & \Rightarrow & V-en \\ [uTHval[]] & & [uTH[]] \\ \dots & & \dots \end{matrix}$$

The properties of a “passivized” verb interact with case theory and the equivalence of little *v* and P to yield the following complete distributional array (where *John* is agent and *Mary* is theme uniformly):

- (11) a. John kisses Mary.  
 b. \*By John kisses Mary.  
 c. Mary is kissed by John.  
 d. \*John is kissed Mary.  
 e. \*Mary is kissed John.

Unaccusative Vs (e.g., *arrive*) might be analyzed similarly: no [AG] feature and lexically unvalued [TH]. Things proceed as with passives; [TH] is valued by *v* (12):

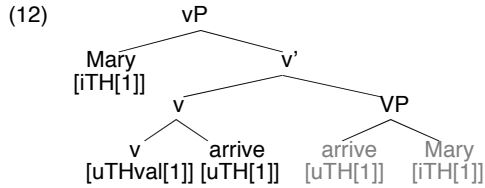

The alternation between little v and P thus offers a simple, but attractive picture of passive voice alternations and related unaccusative constructions.

**1.3 Applicative Shift (“A-Shift”)**

In discussing oblique ditransitive constructions in Lecture 1, we noted that direct merge of the goal (*Mary*) with *give* yields an unvalued [GL] (13):

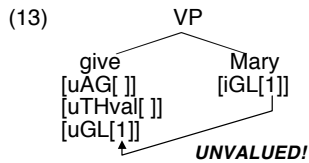

A solution was to value [GL] by means of P (*to*). Recall (14):

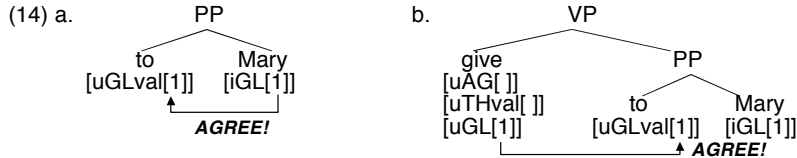

Suppose that instead of proceeding as in (14), we continue from (13) by merging the theme *Fido*, then merging a co-selected little v voice head bearing valued [GL]. V raises and v-V agree (15).

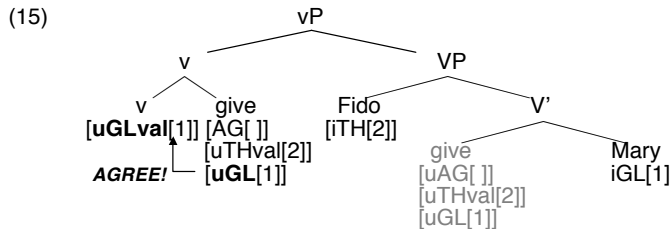

Transitivity of agreement obtains here too. *Mary* agrees with *give* on [GL], and *give* agrees with little v on [GL]; hence *Mary* agrees with little v on [GL]. Since *Mary* and little v agree, v can activate its EEP feature, raising *Mary* across the theme (16):

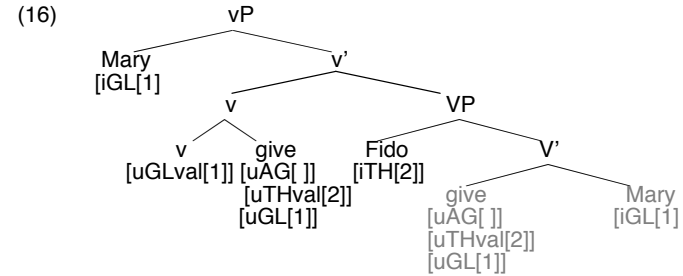

Once again, transitivity of agreement circumvents minimality. Little v needn't probe past *Fido* to agree with *Mary*. Agreement occurs through raised V.

Structure (16) can now merge with little v bearing valued [AG]. The V complex raises and agrees with v (17a). The agent (*John*) merges, agreeing on [AG] (17b):

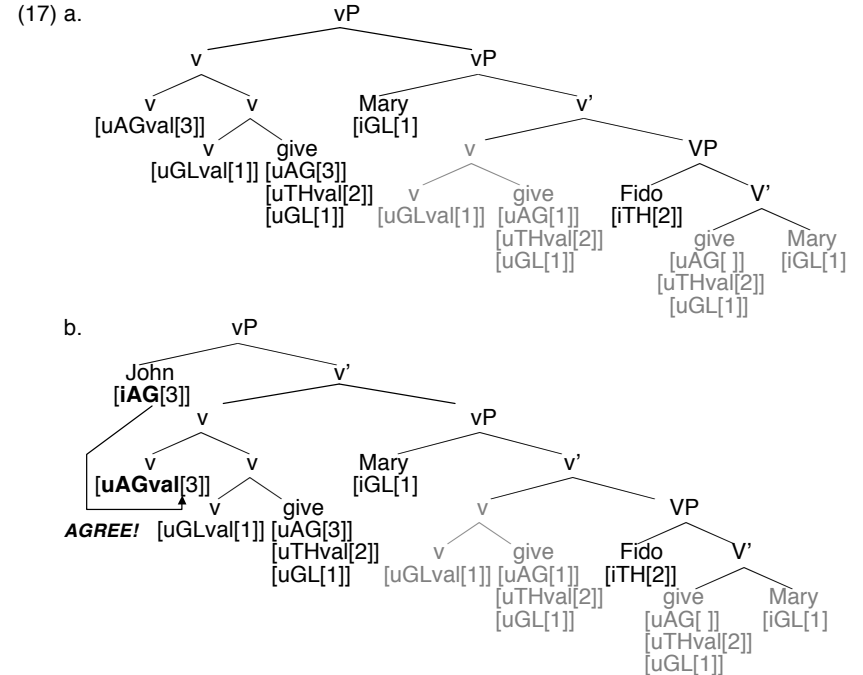

**Proposal:** (15)-(17) is the derivation for applicatives, including DO constructions. Call movement in (16) **Applicative Shift** or “A-shift”. The crucial difference between the A-Shift and oblique derivations lies in how we value the [GL] on *give*:

- With obliques, valuation is by P(14b).
- With applicatives, valuation is by little v (16).

This entails the difference in final structure position:

- Availability of P to value [GL] in constituency with the goal phrase permits the latter to remain low, where the θ-Hierarchy dictates its merge position.
- In (15)-(17), *Mary* also merges low. But because little v valued for [GL] and bearing EPP merges higher, *Mary* must follow it to a higher position, crossing the theme.

### 1.4 Observations and Comparisons

The A-Shift analysis preserves some aspects of the Larson (1998) account:

- Retains the connection between double objects/applicatives & passives; both involve inversion of an initially lower arg around an initially higher one.
- Inversion is to an A-position - spec of a verbal head (little v).
- Oblique phrases, at least those of circumstantial content (goal, location, manner, duration, instrument, cause/purpose), constitute low inner complements of the verb, not adjuncts. Movement from such positions is thus A-movement.

But the two accounts also diverge in significant ways.

**Larson (1998):** locates voice alternation in **X-bar theory**: in whether projection of an additional arg (ZP) from the structure in (18a) follows the standard template (18b) or a special “adjunct projection” template (18c):

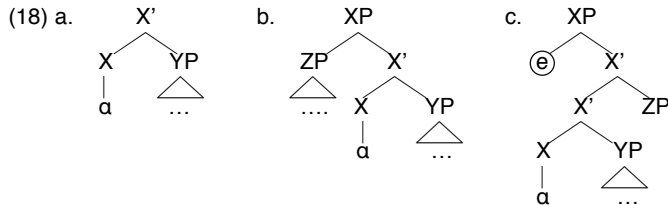

Projection by (18b) yields oblique datives/locatives, and active transitives (19a-c); args occupy positions dictated by the Thematic Hierarchy:

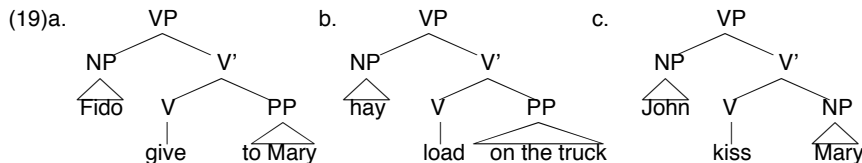

Projection by (18c) yields DO datives, *with/of*-locatives, and passives (20a-c); lower args raise from their original merge site to the empty spec position in (18c):

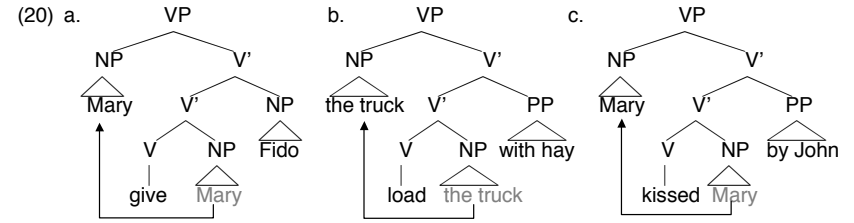

In (20a-c), the outer arg is an **adjunct**, equivalent to an RG chomeur.

**A-Shift Analysis:** locates voice alternation in an equivalence of little v and P in the valuing of θ-features (21):

$$(21) \quad \begin{matrix} v & P \\ [u\theta val[]] & \Leftrightarrow & [u\theta val[]] \end{matrix}$$

The P-option yields oblique datives/locatives, with the roughly the same structures as before. Args occupy positions dictated by the Thematic Hierarchy (22a,b):

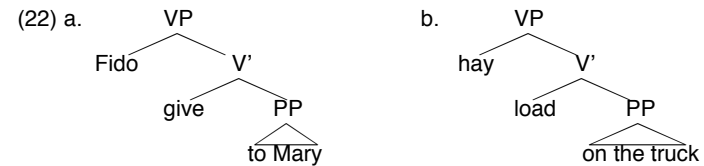

Little v-option yields DO datives and *with/of*-locatives (23a,b); args undergo inversion:

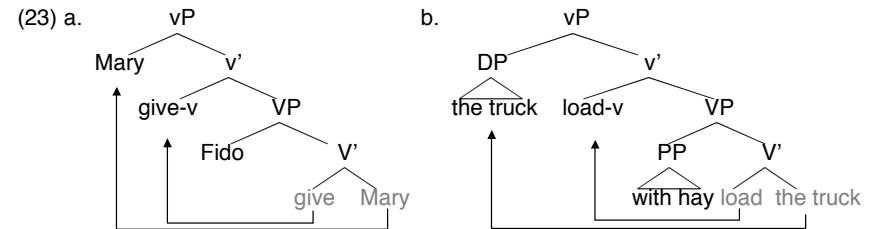

**Passives:** a “mixed” picture (24a,b).

Like obliques, passives use P (*by*) to value a θ-feature ([AG]). PP occurs in a position dictated by the θ-Hierarchy (24a).

Like double objects and *with-of* locatives, passives involve V-raising and inversion of a lower arg (24b).

**Active transitives:** also a “mixed” picture (24c).

Like oblique datives/locatives, args appear in positions dictated by  $\theta$ -Hierarchy (no inversion).

Like DOs and *with-of* locatives, valuation of the non-theme  $\theta$ -feature occurs via little v, not P.

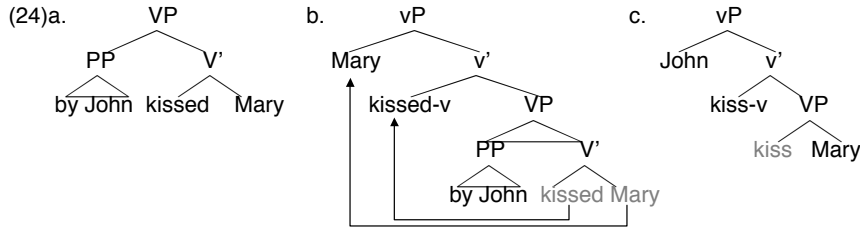

In all the inversion structures (23a,b)/(24b), the lowest arg is not an adjunct, but a **normal specifier**, projected by External Merge.

**1.5 Which Form is “Basic”?**

Larson (1998) embodies the view of Chomsky (1955/75) and many subsequent author that in the dative alternation, oblique form is “basic”.

- Obliques project by standard X-bar theory with args in expected  $\theta$ -Hierarchy positions, and licensed smoothly by case theory.
- DOs project by special, non-compositional X-bar template to ensure a landing site for movement; an extended notion of “case-absorption” is needed to remove the dative *to*.

A-Shift analysis:

- Obliques and DOs/applicatives employ the same structure building operations. No appeal to “case-absorption” for DOs. *To* is not part of the numerations that build DO forms, its role being taken by little v.
- Although double object forms involve inversion, and args thematically “out of place,” what produces this is universal in nature. Little v voice heads are available to the numeration as an option of UG. Likewise,  $\theta$ -features, EPP features and agreement are universally given.
- By contrast, oblique form derivations make essential use of language-specific lexical elements – Ps – whose semantic content must be acquired by the learner and mapped to compatible  $\theta$ -features.

**Conclusion:** Although the DO form involves arg inversion, it’s not clear this implies a more “basic” or “less complex” status for PP form. Although P and v are equivalent in bearing valued  $\theta$ -features, they are not equivalent *tout court*.

Little v’s are “pure” bearers of  $\theta$ -features, with no independent semantic content, and no independent lexical status. Nothing about them needs to be learned.

Ps are “impure” bearers, whose  $\theta$ -features are mixed with independent lexical content. This mixture must be learned and coordinated with the properties of the constructions in which they occur. Oblique constructions thus always involve an additional lexical content that DO/applicative forms do not.

**1.6 Relations to Other Theories**

**Baker (1996):** The A-Shift analysis (17b) resembles that of Baker (1996b) in overall geometry.

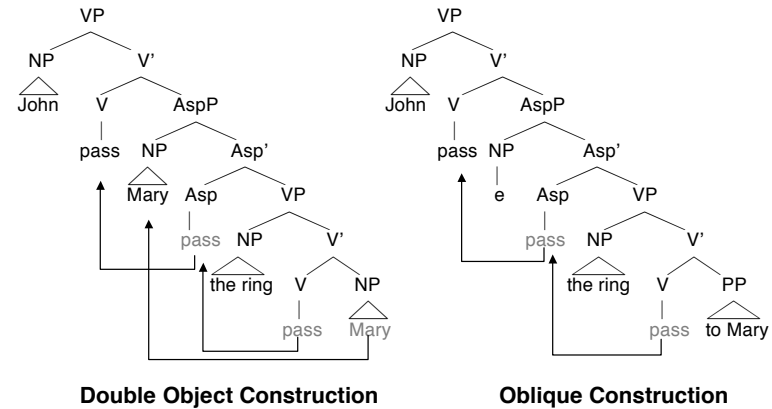

- Theme occupies the same position in DO and oblique forms.
- A functional proj FP that is the target of movement intervenes between an upper VP containing the agent and a lower VP containing the theme.

Differences:

- for Baker FP = AspP
- for A-Shift FP = vP

This difference is relevant to minimality. A-Shift can exploit the transitive agreement between little v, lexical V and the lower goal phrase to allow inversion analysis with no minimality violation.

Since verbal  $\theta$ -features are plausibly confined to verbal categories (v/V), this general approach does not seem available to the AspP analysis; there are no obvious grounds for identifying Asp as a potential bearer of [GL]. Hence minimality questions remain.

**den Dikken (1995) and Oba (2002):** A-Shift can capturing connections made by den Dikken (1995)/Oba (2002) between ditransitive and transitive/oblique possessives.

Oblique-copular possessives and *have* possessives can be related by A-Shift (Larson in prep). Oblique-copular possessives derive like PP datives, with P supplying the valued θ-feature. Compare (25a) with *belong* to the relevant derivational stage with *give* (25b).

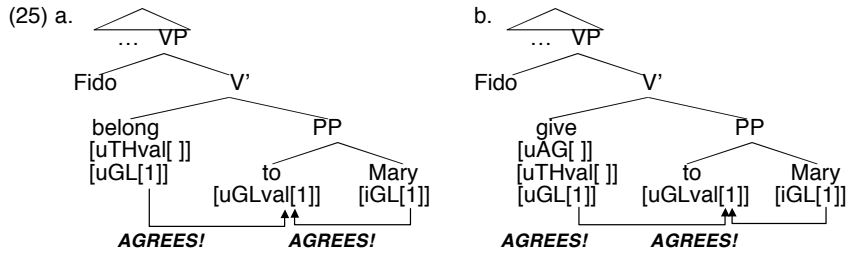

*Have* possessives derive like DOs, where valued θ-feature is resident on a little *v* voice head. Compare (26a) to the relevant derivational stage with *give* (26b):

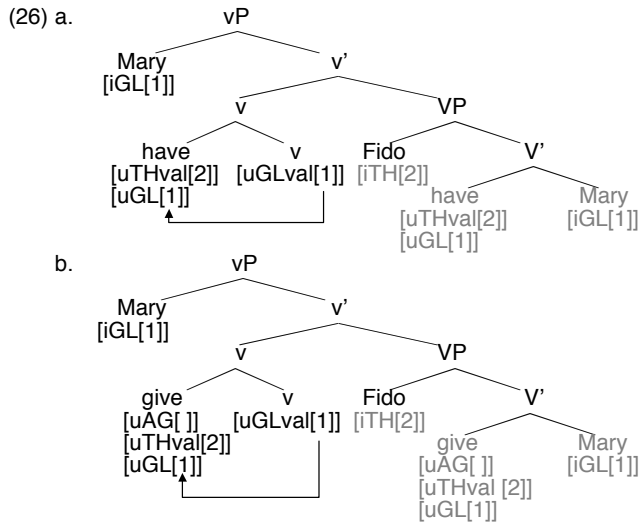

**Marantz (1984,1993):** A-Shift strongly converges with Marantz (1993), who analyzes DO structures as applicatives (27). Apart from node labels, virtually the only difference between (29a,b) is that the latter identifies the “mystery element” X left unspecified and virtually undiscussed in Marantz (1993).

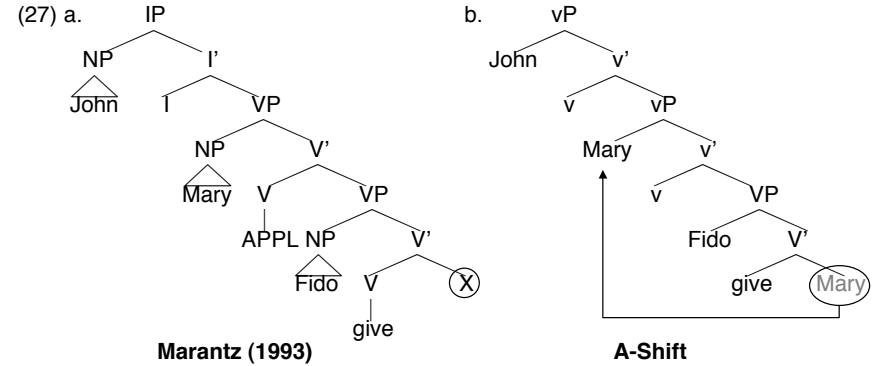

Marantz (1984) proposes that oblique derivation alternates with one where an applicative affix, morphologically merged with V, contributes essentially the same derivational content as P (but without literal incorporation a la Baker (1988)). A-Shift analysis preserves this basic idea, identifying the shared content provided by P and the verbal element (*v*) as θ-features.

Thus A-Shift = derivational version of Marantz (1993), providing a theory of projection, specifying missing elements, and incorporating important ideas from Marantz (1984).

### 1.7 Non-dative Applicatives and Variation

A-Shift appears to offer a sufficiently general account of projection so as to span the range of applicative-oblique relations observed earlier. I.e., A-Shift can be offered as the derivational bridge between the two structures, answering the implicit question of relationship “←??→” that was posed above:

(28)	<b>Applicative</b>		<b>Oblique</b>
<b>Form:</b>	α V-APP β γ	←A-Shift→	α V γ [P β]
<b>Sense:</b>	CAUSED POSSESSION BENEFACTIVE/MALEFACTIVE/ SUBSTITUTIVE INSTRUMENTAL CAUSED MOTION/LOCATION STIMULATIVE MANNER REASON		CAUSED POSSESSION BENEFACTIVE/MALEFACTIVE/ SUBSTITUTIVE INSTRUMENTAL CAUSED MOTION/LOCATION STIMULATIVE MANNER REASON

**Example:** a locative applicative equivalent to *John put Fido there* receives the analysis in (29), where the relevant θ-feature is now [LOC] rather than [GL], but where the derivation is identical to (1b) in all other respects:

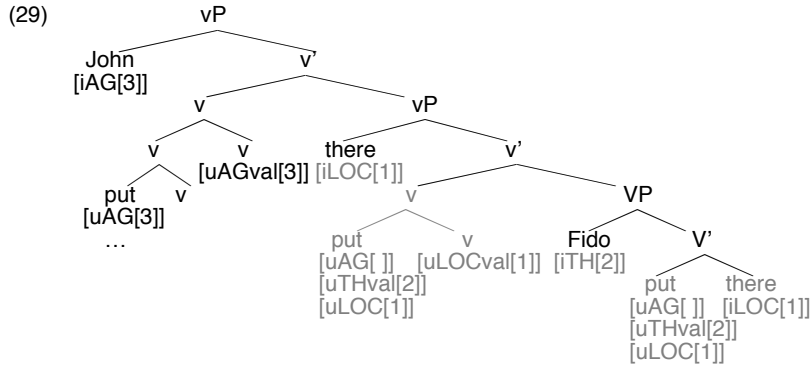

**Immediate Questions:**

- If (29) is derivationally possible, why are **DO locatives** blocked in English?
- Why are **DO datives** blocked in other languages?

**Tentative Answer:** Case.

Chomsky (1993) suggests little v as a source of accusative case: v [AG],[ACC]

**Proposal:** v [GL] is also a source of accusative case in lgs that permit DOs/appls. I.e., v [GL] is actually v [GL],[ACC]:

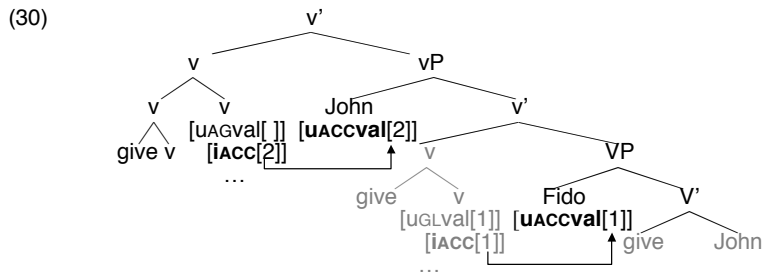

More generally, suppose voice heads (v's bearing valued [θ]) are potential bearers of [ACC]. Lgs may then differ according to which v's bear ACC?

- In E. Portuguese: v [AG]
- In English: v [AG], v [GL], v [BEN]
- In Chichewa: v [AG], v [GL], v [BEN], v [INS], v [LOC]

**Note 1:** On the analysis of *have* possessives in (26b) (above), lack of v [AG] entails v [GL] must be a source of ACC. This captures Harley's (2002) correlation that languages with DO derivations overwhelmingly have transitive possessives.

**Note 2:** There is one class of DO structures that doesn't require a voice head other than v [AG]. In *spray-load* locatives the outer obj is oblique:

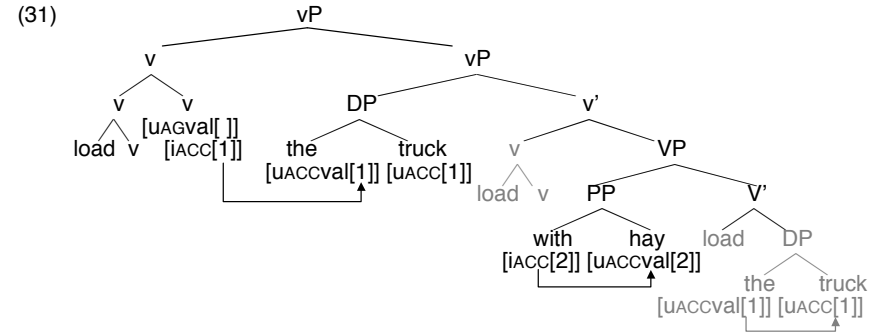

The prediction is thus that *spray-load* forms should be more generally available than other DO/Appl forms.

**2.0 DP Projection**

In the closing portion of this talk I'd like to return to the issue of "categorial neutrality," looking at the case of DP. I will try to develop the picture sketched above enough to show.

**2.1 The DP-IP Analogy**

Thinking about DP structure has been strongly influenced by Abney (1987), who claimed:

- Nominals are headed by their determiner element D, and hence belong to category DP.
- D plays a role in the nominal similar to I in the clause (32)

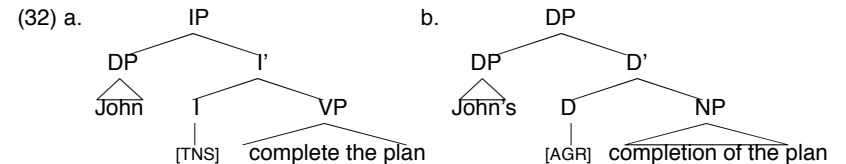

The IP(TP)-DP analogy has exerted enormous influence on research into nominal structure.

A key feature in Abney's analysis is his assimilation of D and I to the class of **functional elements**:

- belong to closed lexical classes
- generally phonologically & morphologically dependent
- permit only one complement, usually not an argument
- usually inseparable from their complement
- lack descriptive or semantic content

Abney (1987; p.65): "The final characteristic...is in some sense the crucial characteristic." The core fact about functional categories is thus that they lack the kind of semantic structure supporting projection like normal, lexical elements.

### 2.2 GQ Theory: the relational view of D

Abney's view of D as a semantically empty contrasts sharply with that of Generalized Quantifier theory, which is based on the "the relational view of determiners":

**Relational View of Determiners:** Determiners express relations among predicate meanings.

GQ theory descends from Frege (1953).

- (33) a. All whales are mammals.  
 b. ALL('whalehood', 'mammalhood')
- (34) a. ALL({x: x is a mammal}, {x: x is a whale})  
 b. ALL(X,Y) iff  $Y \subseteq X$   
 c. {x: x is a whale}  $\subseteq$  {x: x is a mammal}
- (35) a. SOME(X,Y) iff  $Y \cap X \neq \emptyset$   
 b. NO(X,Y) iff  $Y \cap X = \emptyset$   
 c. THE(X,Y) iff  $Y \subseteq X$  &  $|Y| = 1$   
 d. BOTH(X,Y) iff  $Y \subseteq X$  &  $|Y| = 2$   
 e. NEITHER(X,Y) iff  $Y \cap X = \emptyset$  &  $|Y| = 2$   
 f. MOST(X,Y) iff  $|Y \cap X| > |Y \cap X|$

### 2.3 Determiners and Valence

Under the relational analysis, Ds have true argument structure and valence, like Vs. Ds like *all* or *most* express binary relations - they select two arguments. They have the status of transitive predicates (transitive predicates of sets not transitive predicates of individuals).

- (36) **Intransitive Ds (Pronouns)**  
 $HE_n(X)$  iff  $g(n) \in X$
- (37) a. **More** men **than** women smoke.  
 b. **Every** boy **except** John and Max smiled.

### (38) Ditransitive Ds

- a. MORE-THAN(X,Y,Z) iff  $|Y \cap X| > |Z \cap X|$   
 b. AS-MANY-AS(X,Y,Z) iff  $|Y \cap X| \geq |Z \cap X|$   
 c. EVERY-EXCEPT(X,Y,Z) iff ALL(X, (Y-Z)) & NO(X,Z)  
 d. NO-EXCEPT(X,Y,Z) iff NO(X, (Y-Z)) & ALL(X,Z)

### 2.3 Determiners, Thematic roles and DP-Projection

Semantic parallels between Vs and Ds extended to  $\theta$ -role and  $\theta$ -role assignment.

**Vs:** canonically describe events; agent, theme, goal, etc. represent the recurring roles that verbal arguments play with respect to those events.

**Ds:** canonically express quantification; concepts like restriction and scope represent the two main recurring roles that set arguments play.

- Restriction:** fixes the domain of quantification  
**Scope:** determines what is true of the individuals in that domain.

Restriction and scope seem relevant to syntactic mapping. Restriction maps to the NP complement of D. Scope is associated with a main clause predication.

**Proposal:** These are the counterparts of verbal  $\theta$ -roles:  $\theta_{RESTRICT}$  and  $\theta_{SCOPE}$ .  
**Extension:** Triadic determiners take for a third set argument, typically introduced by an oblique P-like element (*than, as, except*). Recognize certain oblique  $\theta$ -roles for nominals:  $\theta_{NOBLIQUE}$ .

### (39) Theta-roles for V vs. D

- V:  $\theta_{AGENT}$ ,  $\theta_{THEME}$ ,  $\theta_{OBLIQUE}$   
 D:  $\theta_{SCOPE}$ ,  $\theta_{RESTRICT}$ ,  $\theta_{NOBLIQUE}$

### 2.4 Projecting DP

Larson (1991) argued that VP and DP show close parallelism and can be projected similarly:

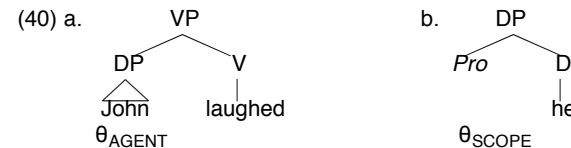



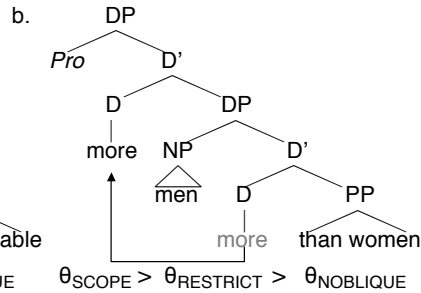
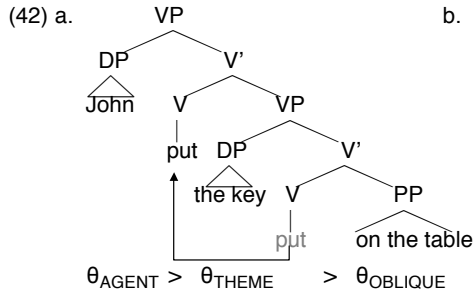
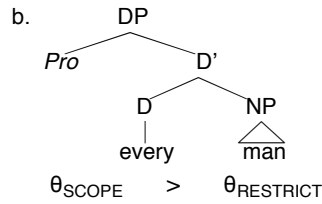
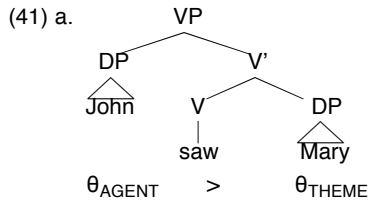

**2.5 θ-Features and θ-Agreement: determiner – restriction term**

Suppose we have θ-features [SCP], [RES], [NOB], etc. Assume the selection relation between a D and its complement is θ-feature agreement (43).

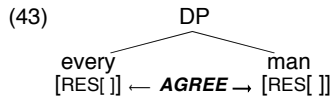

Reasoning from the verbal case, where the argument instances of θ-features are interpretable, we want (44) since the predicates are the args of D:

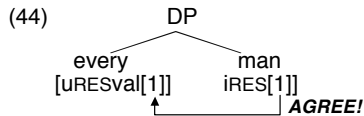

**2.6 θ-Features and θ-Agreement: determiner – scope term**

Suppose we wish to merge *Pro* with structure (44) as its scope term. *Pro* should bear the interpretable θ-feature [iSCP]. If the constraint on bearing valued features holds for D as for V, then (45) faces the same problem we found in the VP case:

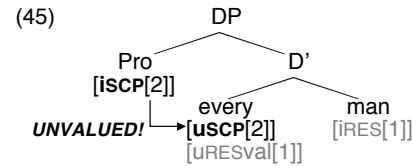

Suppose then that we can have little *d*, analogous to little *v*:

**Light d:** Bears a strong D feature. Bears an EPP feature. Bears one valued occurrence of a θ-feature unvalued on a D with which it was co-selected.

This permits a Numeration for *every man* that includes a light *d* carrying [uSCPval[ ]]. Merge this with (44); D raises and d-D agree (46).

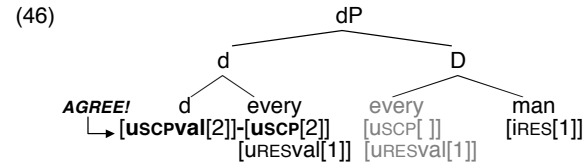

*Pro* can now merge with this structure, satisfying *d*'s EPP feature. Unvalued [iSCP[ ]] on *Pro* probes valued [uSCPval[2]] on *d* and Agrees.

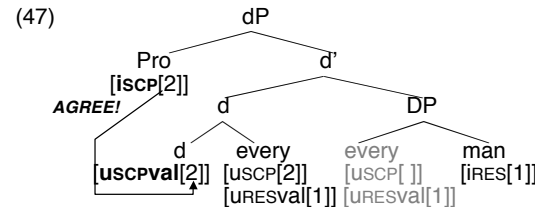

The result is now an LF-legible feature, and an interface-legible structure.

**2.7 θ-Features and θ-Agreement: determiner –oblique argument**

Consider ditransitive *more*. Suppose it has θ-features as in (48):

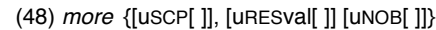

We face the same issues as we did with *give*. Direct merge of the nominal oblique will not yield a valued feature.

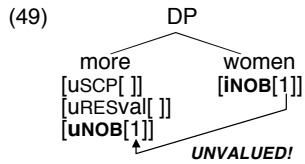

If we have the same possibilities as in the verbal domain, we can value through P:

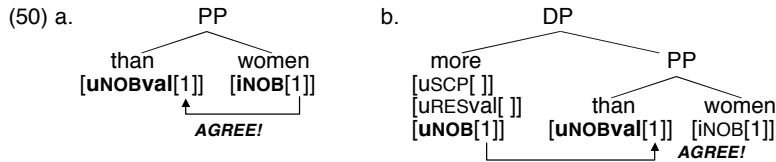

The rest goes as before. The restriction merges directly since [RES] is valued on *more*. The scope is valued by little d, which also raises D (51):

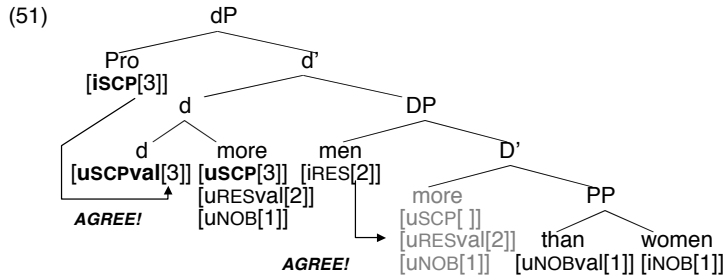

**2.8 Multiple Oblique Arguments and Recursion**

If the D-system is allowed to have a “pure” little d, just like the V-system, then recursion with rightward descent will be possible. The lowest d in (52) will be “pure d” (no θ feature), whereas the highest d will bear [SCP]:

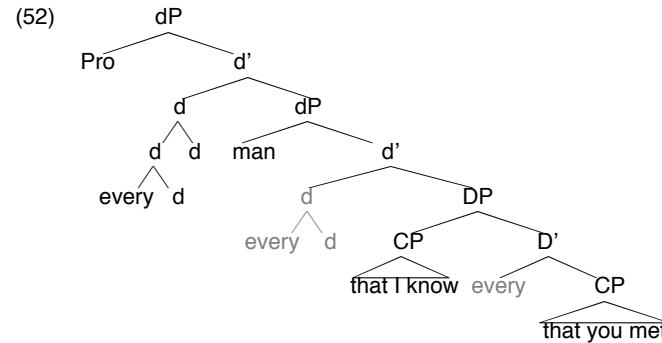

**2.9 Voice alternation in DP?**

The postulation of a *Pro* subject in all DPs has strong consequences for the analysis of prenominal genitive constructions like (53a-d):

- (53) a. John’s briefcase
- b. John’s picture
- c. John’s grandmother
- d. John’s completion of the plan

Recall Abney (1987) assimilates genitive DPs to clauses (IPs), with the possessive element occupying a subject-like position (32a,b). Szabolsci (1983) further develops the analogy with Hungarian examples like (54), where the possessive item co-occurs with a definite article. Szabolsci analyzes the latter as counterpart to a complementizer.

- (54) (a) Mari kalap-ja-i
- (the) Mari hat-POSS-PL-2SG
- ‘Mari’s hats’

The analysis of DP structure developed here does not comport with the sentential analogy. If the thematic “subject” is always the scope argument *Pr*, the possessive item can’t be parallel to a subject; by extension, the Hungarian definite D can’t be parallel to a complementizer.

Larson (1991) proposes that PP and DO datives in the verbal system are paralled by PP and prenominal genitives in the nominal system. Specifically, DO datives and prenominal genitives both involve inversion (53)/(54).

(This idea has been recently taken up by Kuppulo (2008) in a nonderivational applicative framework.)

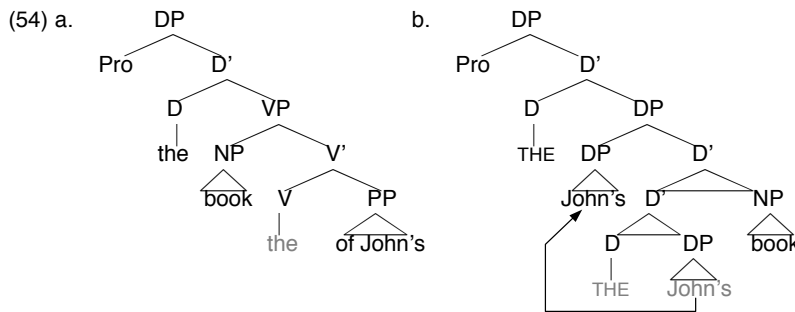
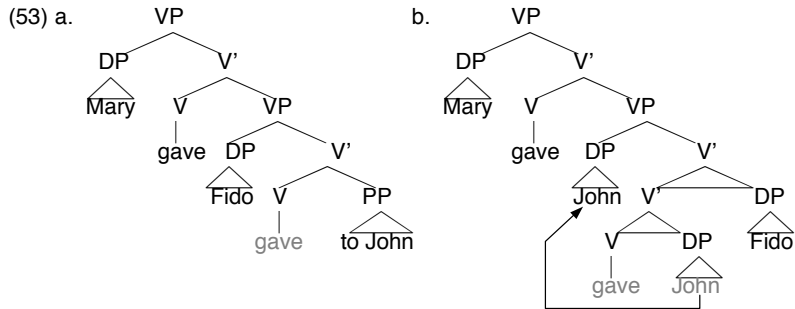

If this comparison is correct, then prenominal genitives represent a voice alternation within DP.

Within the current system, the counterpart of (54a) is parallel to the ditransitive D *more*: we use the P option for the lower complement, which we here take to involve an unpronounced possessive D THE bearing the genitive θ-role [GEN] (55):

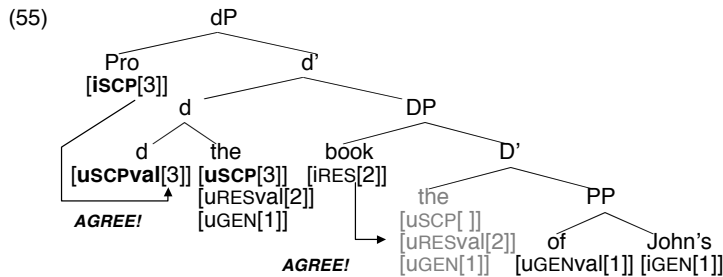

By contrast *John's book* receives an applicative derivation as in (56), where we select d voice head bearing [GEN]:

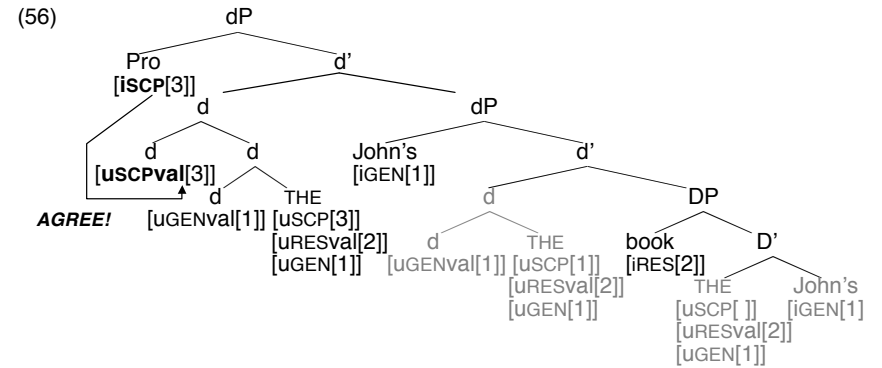

Under this view there is strong symmetry between the vP/VP the dP/DP systems. The account of structure building seems to extend naturally to both, exhibiting the “category neutral” character of the original shell analysis.

### Summary

In this series we looked at:

- the historical origins of shell theory as an attempt to import Right Wrap derivations into the EST
- the properties of shell theory (generalized asymmetry, recursivity, categorial neutrality) and also the problems it encountered
- the logic of θ-roles under the “standard” Fregean semantic picture
- a re-thinking of that logic under neo-Davidsonian semantics – the “K analysis”
- an execution of θ-roles as features combining P&T(2004) and the K analysis
- an account of structure building in these terms, which reconstructs shell structure and inherits its essential properties
- fundamental properties of the dative alternation and the question of projection; we found no evidence supporting separate projection of DOs and PP caused possession structures
- applicative structures as presenting the question of relatedness in its most general and most revealing form.
- our structure building apparatus as applied to voice alternations (passive, A-Shift); these could be seen as reflecting a basic, formal option between v and P in feature valuation.
- the fact that, if one accepts Generalized Quantifier theory, it appears perfectly sensible to extend notions of thematic selection to Ds
- our structure building apparatus as extended into the DP domain.
- our account of dative alternation in vP/VP as extended to genitive alternation in the dP/DP domain.

Thank you! **CRISSP Rocks!**